



647511 EN (09/09/2016)

MT 625 H EASY 49K ST3A S1

**OPERATOR'S MANUAL**  
*(ORIGINAL INSTRUCTIONS)*

**IMPORTANT**

*Carefully read and understand this instruction manual before using the lift truck.*

*It contains all information relating to operation, handling and lift truck equipment,  
as well as important recommendations to be followed.*

*This document also contains precautions for use, as well as information on the servicing and routine maintenance required  
to ensure the lift truck's continued safety of use and reliability.*

**WHENEVER YOU SEE THIS SYMBOL IT MEANS:**



**WARNING ! BE CAREFUL ! YOUR SAFETY OR THE SAFETY OF THE LIFT TRUCK IS AT RISK.**

- This manual has been produced on the basis of the equipment list and the technical characteristics given at the time of its design.
- The level of equipment of the lift truck depends on the options chosen and the country of sale.
- According to the lift truck options and the date of sale, certain items of equipment/functions described herein may not be available.
- Descriptions and figures are non binding.
- MANITOU reserves the right to change its models and their equipment without being required to update this manual.
- The MANITOU network, consisting exclusively of qualified professionals, is at your disposal to answer all your questions.
- This manual is an integral part of the lift truck.
- It is to be kept in its storage space at all times for ease of reference.
- Hand this manual to the new owner if the lift truck is resold.

1st ISSUE	16/01/2015	
UPDATED	15/12/2015	1-3 ; 1-7 ; 1-9 ; 1-21 ; 1-24 ; 1-26 3-5 – 3-9 ; 3-18 – 3-27
	09/09/2016	2-29 ; 2-30

Manitou BFS.A Limited liability company with a Board of Directors.  
 Head office: 430, Rue de l'Aubinière - 44150 Ancenis - FRANCE  
 Share capital: 39,548,949 euros  
 857 802 508 RCS Nantes.  
 Tel: +33 (0)2 40 09 10 11  
[www.manitou.com](http://www.manitou.com)

*This manual is for information purposes only. Any reproduction, copy, representation, recording, transfer, distribution, or other, in part or in whole, in any format is prohibited. The plans, designs, views, commentaries and instructions, even the document organization that are found in this document, are the intellectual property of MANITOU BF. Any violation of the aforementioned may lead to civil and criminal prosecution. The logos as well as the visual identity of the company are the property of MANITOU BF and may not be used without express and formal authorization. All rights are reserved.*

647511 (09/09/2016)  
 MT 625 H E6SY 49 K3BA S1

**1 - OPERATING AND SAFETY INSTRUCTIONS**

**2 - DESCRIPTION**

**3 - MAINTENANCE**

**4 - OPTIONAL ATTACHMENTS FOR USE WITH THE RANGE**



# ***1 - OPERATING AND SAFETY INSTRUCTIONS***

## ASSISTANCE | 23 SIMPLE TIPS

The Manitou Group wishes to assist you in reducing the consumption of the machines to help you reduce your carbon footprint.



Chose a machine with an appropriate power rating for your needs.



Switch off your engine after running at idle for more than 3 minutes.



Optimum engine efficiency is achieved at the maximum torque engine speed.



Preferably use a fan control and reversal system.



Favor "smart" electronically-managed transmissions.



Use the air-conditioning with windows and doors closed.



Preferably use LED headlights.



Adapt the type of tire to your environment.



Ensure that your tires are inflated to the correct pressure.



Check the parking brake adjustment.

### Preferably use manufacturer-recommended attachments



Check the general condition of your trailer.



Adapt your maximum towable load.



Use the attachments that are suitable for your machine.



Check the hydraulic adjustment of your attachments.



Observe the maintenance periods.



Regularly clean the radiator, the air filter, etc.



Lubricate regularly.



Preferably buy through a manufacturer-approved dealer.



Favor OEM parts.



Study the manufacturers' maintenance contracts.



You can follow eco-driving courses.



Demand to know the consumption and emissions of the machines.



Calculate your consumption and emissions at [reduce.manitou.com](http://reduce.manitou.com)

## TABLE OF CONTENTS

### 1 - OPERATING AND SAFETY INSTRUCTIONS

<b><u>INSTRUCTIONS TO THE COMPANY MANAGER</u></b>	<b>6</b>
<b>THE SITE</b>	<b>6</b>
<b>THE OPERATOR</b>	<b>6</b>
<b>THE LIFT TRUCK</b>	<b>6</b>
A - THE TRUCK'S SUITABILITY FOR THE JOB . . . . .	6
B - ADAPTATION OF THE LIFT TRUCK TO STANDARD ENVIRONMENTAL CONDITIONS . . . . .	6
C - MODIFICATION OF THE LIFT TRUCK . . . . .	7
D - FRENCH ROAD TRAFFIC RULES . . . . .	7
E - LIFT TRUCK CAB PROTECTION . . . . .	7
<b>THE INSTRUCTIONS</b>	<b>7</b>
<b>THE MAINTENANCE</b>	<b>7</b>
<b><u>INSTRUCTIONS FOR THE OPERATOR</u></b>	<b>8</b>
<b>PREAMBLE</b>	<b>8</b>
<b>GENERAL INSTRUCTIONS</b>	<b>8</b>
A - OPERATOR'S MANUAL . . . . .	8
B - AUTHORISATION FOR USE IN FRANCE . . . . .	8
C - MAINTENANCE . . . . .	8
D - MODIFICATION OF THE LIFT TRUCK . . . . .	8
E - LIFTING PEOPLE . . . . .	9
<b>OPERATING INSTRUCTIONS UNLADEN AND LADEN</b>	<b>9</b>
A - BEFORE STARTING THE LIFT TRUCK . . . . .	9
B - DRIVER'S OPERATING INSTRUCTIONS . . . . .	9
C - ENVIRONMENT . . . . .	9
D - VISIBILITY . . . . .	10
E - STARTING THE LIFT TRUCK . . . . .	11
F - DRIVING THE LIFT TRUCK . . . . .	11
G - STOPPING THE LIFT TRUCK . . . . .	12
H - DRIVING THE LIFT TRUCK ON THE PUBLIC HIGHWAY . . . . .	13
<b>INSTRUCTIONS FOR HANDLING A LOAD</b>	<b>14</b>
A - CHOICE OF ATTACHMENTS . . . . .	14
B - MASS OF LOAD AND CENTRE OF GRAVITY . . . . .	14
C - LONGITUDINAL STABILITY LIMITER AND WARNING DEVICE . . . . .	14
D - TRANSVERSE ATTITUDE OF THE LIFT TRUCK . . . . .	15
E - TAKING UP A LOAD ON THE GROUND . . . . .	15
F - TAKING UP AND LAYING A HIGH LOAD ON TYRES . . . . .	16
G - TAKING UP AND LAYING A HIGH LOAD ON STABILIZERS . . . . .	18
H - TAKING UP AND LAYING DOWN A SUSPENDED LOAD . . . . .	20
I - TRAVELLING WITH A SUSPENDED LOAD . . . . .	20
<b>PLATFORM OPERATING INSTRUCTIONS</b>	<b>21</b>
A - AUTHORISATION FOR USE . . . . .	21
B - LIFT TRUCK SUITABILITY FOR USE . . . . .	21
C - PRECAUTIONS WHEN USING THE PLATFORM . . . . .	21
D - USING THE PLATFORM . . . . .	21
E - ENVIRONMENT . . . . .	21
F - MAINTENANCE . . . . .	22
<b>INSTRUCTIONS FOR USING THE RADIO-CONTROL</b>	<b>23</b>
HOW TO USE THE RADIO-CONTROL . . . . .	23
PROTECTIVE DEVICES . . . . .	23

<b><i>LIFT TRUCK MAINTENANCE INSTRUCTIONS</i></b>	<b>24</b>
<b>GENERAL INSTRUCTIONS</b>	<b>24</b>
<b>PLACING THE JIB SAFETY WEDGE</b>	<b>24</b>
FITTING THE WEDGE . . . . .	24
REMOVING THE WEDGE . . . . .	24
<b>MAINTENANCE</b>	<b>24</b>
MAINTENANCE LOGBOOK . . . . .	24
<b>LUBRICANT AND FUEL LEVELS</b>	<b>25</b>
<b>HYDRAULIC</b>	<b>25</b>
<b>ELECTRICITY</b>	<b>25</b>
<b>WELDING</b>	<b>25</b>
<b>WASHING THE LIFT TRUCK</b>	<b>25</b>
<b>TRANSPORTING THE LIFT TRUCK</b>	<b>25</b>
<b><i>IF THE LIFT TRUCK IS NOT TO BE USED FOR A LONG TIME</i></b>	<b>26</b>
<b>INTRODUCTION</b>	<b>26</b>
<b>PREPARING THE LIFT TRUCK</b>	<b>26</b>
<b>PROTECTING THE ENGINE</b>	<b>26</b>
<b>PROTECTING THE LIFT TRUCK</b>	<b>26</b>
<b>BRINGING THE LIFT TRUCK BACK INTO SERVICE</b>	<b>26</b>
<b><i>LIFT TRUCK DISPOSAL</i></b>	<b>27</b>
<b>RECYCLING OF MATERIALS</b>	<b>27</b>
METALS . . . . .	27
PLASTICS . . . . .	27
RUBBER . . . . .	27
GLASS . . . . .	27
<b>ENVIRONMENTAL PROTECTION</b>	<b>27</b>
WORN OR DAMAGED PARTS . . . . .	27
USED OIL . . . . .	27
USED BATTERIES . . . . .	27



## INSTRUCTIONS TO THE COMPANY MANAGER

### THE SITE

Proper management of lift truck's area of travel will reduce the risk of accidents:

- ground not unnecessarily uneven or obstructed,
- no excessive slopes,
- pedestrian traffic controlled, etc.

### THE OPERATOR

- Only qualified, authorized personnel can use the lift truck. This authorization is given in writing by the appropriate person in the establishment with respect to the use of lift trucks and must be carried permanently by the operator.

#### **⚠ IMPORTANT ⚠**

*Experience has shown that there are a number of inappropriate ways in which the lift truck might be used. Such foreseeable misuse, of which the main examples are listed below, are strictly forbidden.*

- *The foreseeable abnormal behaviour resulting from ordinary negligence, but which does not result from any wish to put the machinery to any improper use.*
  - *The reflex reactions of a person in the event of a malfunction, incident, fault, etc. during operation of the lift truck.*
  - *Behaviour resulting from application of the "principle of least effort" when performing a task.*
- *For certain machines, the foreseeable behaviour of such persons as: apprentices, teenagers, handicapped persons, trainees tempted to drive a lift truck, operators tempted to operate a truck for the purposes of a bet, a competition or for their own personal experience.*  
*The person in charge of the equipment must take these criteria into account when assessing the suitability of a person to drive.*

### THE LIFT TRUCK

#### A - THE TRUCK'S SUITABILITY FOR THE JOB

- MANITOU has ensured that this lift truck is suitable for use under the standard operating conditions defined in this operator's manual, with a **STATIC** test coefficient **OF 1,33** and a **DYNAMIC** test coefficient **OF 1**, as specified in harmonised standard **EN 1459** for variable range trucks.
- Before commissioning, the company manager must make sure that the lift truck is appropriate for the work to be done, and perform certain tests (in accordance with current legislation).

#### B - ADAPTATION OF THE LIFT TRUCK TO STANDARD ENVIRONMENTAL CONDITIONS

- In addition to series equipment mounted on your lift truck, many options are available, such as: road lighting, stop lights, revolving light, reverse lights, reverse buzzer alarm, front light, rear light, light at the jib head, etc. (according to the lift truck model).
- The operator must take into account the operating conditions to define the lift truck's signalling and lighting equipment. Contact your dealer.
- Take into account climatic and atmospheric conditions of the site of utilisation.
  - Protection against frost (see: 3 - MAINTENANCE: LUBRICANTS AND FUEL).
  - Adaptation of lubricants (ask your dealer for information).
  - Engine filtration (see: 3 - MAINTENANCE: FILTERS CARTRIDGES AND BELTS).

#### **⚠ IMPORTANT ⚠**

*For operation under average climatic conditions, i.e.: between -15 °C and +35 °C, correct levels of lubricants in all the circuits are checked in production.*  
*For operation under more severe climatic conditions, before starting up, it is necessary to drain all the circuits, then ensure correct levels of lubricants using lubricants properly suited to the relevant ambient temperatures.*  
*The same applies to the cooling liquid.*

- A lift truck operating in an area without fire extinguishing equipment must be equipped with an individual extinguisher. There are solutions, consult your dealer.

#### **⚠ IMPORTANT ⚠**

*Your lift truck is designed for outdoor use under normal atmospheric conditions and indoor use in suitably aerated and ventilated premises.*

*It is prohibited to use the lift truck in areas where there is a risk of fire or which are potentially explosive (e.g. Refineries, fuel or gas depots, stores of flammable products, etc.).*

*For use in these areas, specific equipment is available (ask your dealer for information).*

- Our trucks comply with Directive 2004/108/EC concerning electromagnetic compatibility (EMC), and with the corresponding harmonized standard EN 12895. Their proper operation is no longer guaranteed if they are used within areas in which the electromagnetic fields exceed the limit specified by that standard (10 V/m).
- Directive 2002/44/EC requires company managers to not expose their employees to excessive vibration doses. There is no recognized code of measurement for comparing the machines of different manufacturers. The actual doses received cannot therefore be measured under actual operating conditions at the user's premises.
- The following are some tips for minimizing these vibration doses:
  - Select the most suitable lift truck and attachment for the intended use.

- Adapt the seat adjustment to the operator's weight (according to lift truck model) and maintain it in good condition, as well as the cab suspension. Inflate the tires in accordance with recommendations.
- Ensure that the operators adapt their operating speed to suit the conditions on site.
- As far as possible, arrange the site in such a way as to provide a flat running surface and remove obstacles and harmful potholes.

### C - MODIFICATION OF THE LIFT TRUCK

- For your safety and that of others, you must not change the structure and settings of the various components used in your lift truck (hydraulic pressure, calibrating limiters, engine speed, addition of extra equipment, addition of counterweight, unapproved attachments, alarm systems, etc.) yourself. In this event, the manufacturer cannot be held responsible.

### D - FRENCH ROAD TRAFFIC RULES

(or see current legislation in other countries)

- Only one certificate of conformity is issued. It must be kept in a safe place.
- The driving of non EC type-approved tractors on the public highway is subject to the provisions of the highway code relating to special machines, defined in article R311-1 of the highway code, in category B of the Equipment Order of 20 November 1969 that determines the procedures applicable to special machines. The lift truck must be fitted with a licence plate.
- The driving of EC type-approved tractors on the public highway is subject to the provisions of the highway code regarding agricultural tractors, defined in article R311-1 of the highway code. The lift truck must be registered.

### SPECIAL INSTRUCTION APPLYING TO "EC TRACTOR" TYPE-APPROVED LIFT TRUCKS

- All EC tractor type-approved lift trucks are supplied with an "EC tractor" certificate complying with directive 2003/37/EC, to be retained by the owner, and a page of administrative details together with a CNIT number (national type approval code) for registration at the prefecture.
- The lift truck owner is responsible for carrying out the necessary procedures for obtaining the vehicle registration document within the time limit defined by the regulations.
- The operator must hold an HGV licence, unless granted an exemption.
- The lift truck must be driven on the public highway in accordance with the instructions given in the manual supplied with the lift truck (Gross weight, Gross combination weight, towing load, axle loads, maximum speeds, etc. according to type/version). The operator must be in possession of the lift truck's registration document.

#### **⚠ IMPORTANT ⚠**

*When towing a trailer or agricultural equipment, the travelling speed of the lift truck is limited to 25 km/h.  
In this case, a "25" disc must be affixed to the rear of the convoy.*

### E - LIFT TRUCK CAB PROTECTION

- All lift trucks comply with the requirements of ISO 3471 (wheel loader code) regarding cab rollover protection (ROPS) and ISO 3449 (Level II) regarding the protection of the cab against falling objects (FOPS).
- "EC TRACTOR" type-approved lift trucks comply, in addition, with Directive 79/622/EC (OECD Code 4) regarding cab rollover protection (ROPS).

#### **⚠ IMPORTANT ⚠**

*Structural damage or overturning, a modification, changes or a poorly executed repair can reduce the protective efficiency of the cab, cancelling its compliance.  
Do not perform welding or drilling on the cab structure.  
Consult your dealer to determine the limits of this structure without cancelling its compliance.*

## THE INSTRUCTIONS

- The operator's manual must always be in good condition and kept in the place provided on the lift truck and in the language used by the operator.
- The operator's manual and any plates or stickers which are no longer legible or are damaged, must be replaced immediately.

## THE MAINTENANCE

- Maintenance or repairs other than those detailed in part: 3 - MAINTENANCE must be carried out by qualified personnel (consult your dealer) and under the necessary safety conditions to maintain the health of the operator and any third party.

#### **⚠ IMPORTANT ⚠**

*Your lift truck must be inspected periodically to ensure that it remains in compliance.  
The frequency of this inspection is defined by current legislation in the country in which the lift truck is used.*

- Example for France "The manager in charge of the establishment using a lift truck must open and maintain a maintenance log for each machine (order of 2 March 2004) and undergo a general periodic inspection every 6 months (order of 1 March 2004)".

# INSTRUCTIONS FOR THE OPERATOR

## PREAMBLE

### ⚠ IMPORTANT ⚠

*The risk of accident while using, servicing or repairing your lift truck can be restricted if you follow the safety instructions and safety measures detailed in these instructions. Failure to respect the safety and operating instructions, or the instructions for repairing or servicing your lift truck may lead to serious, even fatal accident.*

- Only the operations and manoeuvres described in these operator's manual must be performed. The manufacturer cannot predict all possible risky situations. Consequently, the safety instructions given in the operator's manual and on the lift truck itself are not exhaustive.
- At any time, as an operator, you must envisage, within reason, the possible risk to yourself, to others or to the lift truck itself when you use it.

### ⚠ IMPORTANT ⚠

*In order to reduce or avoid any danger with a MANITOU-approved attachment, follow the instructions of paragraph:  
4 - ADAPTABLE ATTACHMENTS IN OPTION ON THE RANGE: INTRODUCTION.*

## GENERAL INSTRUCTIONS

### A - OPERATOR'S MANUAL

- Read the operator's manual carefully.
- The operator's manual must always be in good condition and in the place provided for it on the lift truck.
- You must report any plates and stickers which are no longer legible or which are damaged.

### B - AUTHORISATION FOR USE IN FRANCE

*(or see current legislation in other countries).*

- Only qualified, authorized personnel can use the lift truck. This authorization is given in writing by the appropriate person in the establishment with respect to the use of lift trucks and must be carried permanently by the operator.
- The operator is not competent to authorise the driving of the lift truck by another person.

### C - MAINTENANCE

- The operator must immediately advise his superior if his lift truck is not in good working order or does not comply with the safety notice.
- The operator is prohibited from carrying out any repairs or adjustments himself, unless he has been trained for this purpose. He must keep the lift truck properly cleaned if this is among his responsibilities.
- The operator must carry out daily maintenance (see: 3 - MAINTENANCE: A - DAILY OR EVERY 10 HOURS SERVICE).
- The operator must ensure tyres are adapted to the nature of the ground (see area of the contact surface of the tyres in the chapter: 2 - DESCRIPTION: TYRES). There are optional solutions, consult your dealer.
  - SAND tyres.
  - LAND tyres.
  - Snow chains.

### ⚠ IMPORTANT ⚠

*Do not use the lift truck if the tyres are incorrectly inflated, damaged or excessively worn, because this could put your own safety or that of others at risk, or cause damage to the lift truck itself.*

*The fitting of foam inflated tyres is prohibited and is not guaranteed by the manufacturer, excepting prior authorisation.*

### D - MODIFICATION OF THE LIFT TRUCK

- For your safety and that of others, you must not change the structure and settings of the various components used in your lift truck (hydraulic pressure, calibrating limiters, engine speed, addition of extra equipment, addition of counterweight, unapproved attachments, alarm systems, etc.) yourself. In this event, the manufacturer cannot be held responsible.

## E - LIFTING PEOPLE

- The use of working equipment and load lifting attachments to lift people is:
  - either forbidden
  - or authorized exceptionally and under certain conditions (see current regulations in the country in which the lift truck is used).
- The pictogram posted at the operator station reminds you that:
  - Left-hand column
    - It is forbidden to lift people, with any kind of attachment, using a non PLATFORM-fitted lift truck.
  - Right-hand column
    - With a PLATFORM-fitted lift truck, people can only be lifted using platforms designed by MANITOU for the purpose.
- MANITOU sells equipment specifically designed for lifting people (OPTION PLATFORM lift truck, contact your dealer).



## OPERATING INSTRUCTIONS UNLADEN AND LADEN

### A - BEFORE STARTING THE LIFT TRUCK

- Perform the daily service (see: 3 - MAINTENANCE: A - DAILY OR EVERY 10 HOURS SERVICE).
- Make sure that the driver's cab is clean, particularly the floor and floor mat. Check that no movable object may hinder the operation of the lift truck.
- Make sure the lights, indicators and windscreen wipers are working properly.
- Make sure the rear view mirrors are in good condition, clean and properly adjusted.
- Make sure the horn works.

### B - DRIVER'S OPERATING INSTRUCTIONS

- Whatever his experience, the operator is advised to familiarize himself with the position and operation of all the controls and instruments before operating the lift truck.
- Wear clothes suited for driving the lift truck, avoid loose clothes.
- Make sure you have the appropriate protective equipment for the job to be done.
- Prolonged exposure to high noise levels may cause hearing problems. It is recommended to wear ear muffs to protect against excessive noise.
- Always face the lift truck when getting into and leaving the driving seat and use the handle(s) provided for this purpose. Do not jump out of the seat to get down.
- Always pay attention when using the lift truck. Do not listen to the radio or music using headphones or earphones.
- Never operate the lift truck when hands or feet are wet or soiled with greasy substances.
- For increased comfort, adjust the seat to your requirements and adopt the correct position in the driver's cab.

#### **⚠ IMPORTANT ⚠**

*Under no circumstances must the seat be adjusted while the lift truck is moving.*

- The operator must always be in his normal position in the driver's cab. It is prohibited to have arms or legs, or generally any part of the body, protruding from the driver's cab of the lift truck.
- The safety belt must be worn and adjusted to the operator's size.
- The control units must never in any event be used for any other than their intended purposes (e.g. climbing onto or down from the lift truck, portmanteau, etc.).
- If the control components are fitted with a forced operation (lever lock) device, it is forbidden to leave the cab without first putting these controls in neutral.
- It is prohibited to carry passengers either on the lift truck or in the cab.

### C - ENVIRONMENT

- Comply with site safety regulations.
- If you have to use the lift truck in a dark area or at night, make sure it is equipped with working lights.
- During handling operations, make sure that no one is in the way of the lift truck and its load.
- Do not allow anybody to come near the working area of the lift truck or pass beneath an elevated load.
- When using the lift truck on a transverse slope, before lifting the boom, follow the instructions given in the paragraph: INSTRUCTIONS FOR HANDLING A LOAD: D - TRANSVERSE ATTITUDE OF THE LIFT TRUCK.

- Travelling on a longitudinal slope:
  - Drive and brake gently.



- Moving without load: Forks or attachment facing downhill.

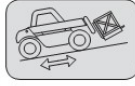

- Moving with load: Forks or attachment facing uphill.
- Take into account the lift truck's dimensions and its load before trying to negotiate a narrow or low passageway.
- Never move onto a loading platform without having first checked:
  - That it is suitably positioned and made fast.
  - That the unit to which it is connected (wagon, lorry, etc.) will not shift.
  - That this platform is prescribed for the total weight of the lift truck to be loaded.
  - That this platform is prescribed for the size of the lift truck.
- Never move onto a foot bridge, floor or freight lift, without being certain that they are prescribed for the weight and size of the lift truck to be loaded and without having checked that they are in sound working order.
- Be careful in the area of loading bays, trenches, scaffolding, soft ground and manholes.
- Make sure the ground is stable and firm under the wheels and/or stabilizers before lifting or removing the load. If necessary, add sufficient wedging under the stabilizers.
- Make sure that the scaffolding, loading platform, pilings or ground is capable of bearing the load.
- Never stack loads on uneven ground, they may tip over.

**⚠ IMPORTANT ⚠**

*If the load or the attachment must remain above a structure for a prolonged period of time, there is the risk that it will bear on the structure as the boom descends due to cooling of the oil in the cylinders.*

*To eliminate this risk:*

- *Regularly check the distance between the load or the attachment and the structure and readjust this if necessary.*
- *If possible use the lift truck at an oil temperature as close as possible to ambient temperature.*

- When working near aerial lines, ensure that the safety distance is sufficient between the working area of the lift truck and the aerial line.

**⚠ IMPORTANT ⚠**

*You must consult your local electrical agency.*

*You could be electrocuted or seriously injured if you operate or park the lift truck too close to power cables.*

*In the event of high winds, do not carry out handling work that jeopardises the stability of the lift truck and its load, particularly if the load catches the wind badly.*

## D - VISIBILITY

- The safety of people within the lift truck's working area, as well as that of the lift truck itself and the operator are depend on good operator visibility of the lift truck's immediate vicinity in all situations and at all times.
- This lift truck has been designed to allow good operator visibility (direct or indirect by means of rear-view mirrors) of the immediate vicinity of the lift truck while travelling with no load and with the boom in the transport position.
- Special precautions must be taken if the size of the load restricts visibility towards the front:
  - moving in reverse,
  - site layout,
  - assisted by a person directing the manoeuvre (while standing outside the truck's area of travel), making sure to keep this person clearly in view at all times,
  - in any case, avoid reversing over long distances.
- Certain special accessories may require the truck to travel with the boom in the raised position. In such cases, visibility on the right hand side is restricted, and special precautions must be taken:
  - site layout,
  - assisted by a person directing the manoeuvre (while standing outside the truck's area of travel).
  - replacement of a suspended load by a load on a pallet.
- If visibility of your road is inadequate, ask someone to assist by directing the manoeuvre (while standing outside the truck's area of travel), making sure to keep this person clearly in view at all times.
- Keep all components affecting visibility in a clean, properly adjusted state and in good working order (e.g. windscreens, windows, windscreen wipers, windscreen washers, driving and work lights, rear-view mirrors).

## E - STARTING THE LIFT TRUCK

### SAFETY INSTRUCTIONS

#### **⚠ IMPORTANT ⚠**

*The lift truck must only be started up or manoeuvred when the operator is sitting in the driver's cab, with his seat belt adjusted and fastened.*

- Never try to start the lift truck by pushing or towing it. Such operation may cause severe damage to the transmission. If necessary, to tow the lift truck in an emergency, the transmission must be placed in the neutral position (see: 3 - MAINTENANCE: G - OCCASIONAL MAINTENANCE).
- If using an emergency battery for start-up, use a battery with the same characteristics and respect battery polarity when connecting it. Connect at first the positive terminals before the negative terminals.

#### **⚠ IMPORTANT ⚠**

*Failure to respect polarity between batteries can cause serious damage to the electrical circuit.  
The electrolyte in the battery may produce an explosive gas. Avoid flames and generation of sparks close to the batteries.  
Never disconnect a battery while it is charging.*

### INSTRUCTIONS

- Check the closing and locking of the hood(s).
- Check that the cab door is closed.
- Check that the forward/reverse selector is in neutral, and that the parking brake is applied.
- Press on the service brake pedal and maintain it down.
- Turn the ignition key to the position I to activate the electrical and pre-heating system.
- Whenever you switch on the lift truck, perform the automatic check on the longitudinal stability limiter and warning device (see: 2 - DESCRIPTION: INSTRUMENTS AND CONTROLS). Do not use the lift truck if it does not conform to the regulations.
- Check the fuel level on the indicator.
- Turn the ignition key fully, the engine should then start. Release the ignition key and let the engine run at idle.
- Do not engage the starter motor for more than 15 seconds and carry out the preheating between unsuccessful attempts.
- Make sure all the signal lights on the control instrument panel are off.
- Check all control instruments when the engine is warm and at regular intervals during use, so as to quickly detect any faults and to be able to correct them without any delay.
- If an instrument does not show the correct display, stop the engine and immediately carry out the necessary operations.

## F - DRIVING THE LIFT TRUCK

### SAFETY INSTRUCTIONS

#### **⚠ IMPORTANT ⚠**

*The operators' attention is drawn to the risks involved in using the lift truck, in particular:*

*- Risk of losing control.*

*- Risk of losing lateral and frontal stability of the lift truck.*

*The operator must remain in control of the lift truck.*

*In the event of the lift truck overturning, do not try to leave the cabin during the incident.*

**YOUR BEST PROTECTION IS TO STAY FASTENED IN THE CABIN.**

- Observe the company's traffic regulations or, by default, the public highway code.
- Do not carry out operations which exceed the capacities of your lift truck or attachments.
- Always drive the lift truck with the forks or attachment to the transport position, i.e. at 300 mm from the ground, the boom retracted and the carriage sloping backwards.
- Only carry loads which are balanced and properly anchored to avoid any risk of a load falling off.
- Ensure that pallets, cases, etc, are in good order and suitable for the load to be lifted.
- Familiarise yourself with the lift truck on the terrain where it will be used.
- Ensure that the service brakes are working properly.
- The loaded lift truck must not travel at speeds in excess of 12 km/h.
- Drive smoothly at an appropriate speed for the operating conditions (land configuration, load on the lift truck).
- Do not use the hydraulic boom controls when the lift truck is moving.
- Never change the steering mode whilst driving.
- Do not manoeuvre the lift truck with the boom in the raised position unless under exceptional circumstances and then with extreme caution, at very low speed and using gentle braking. Ensure that visibility is adequate.
- Take bends slowly.
- In all circumstances make sure you are in control of your speed.
- On damp, slippery or uneven terrain, drive slowly.
- Brake gently, never abruptly.
- Only use the lift truck's forward/reverse selector from a stationary position and never do so abruptly.
- Do not drive with your foot on the brake pedal.
- Always remember that hydrostatic type steering is extremely sensitive to movement of the steering wheel, so turn it gently and not jerkily.
- Never leave the engine on when the lift truck is unattended.

- Do not leave the cab when the lift truck has a raised load.
- Look where you are going and always make sure you have good visibility along the route.
- Use the rear-view mirrors frequently.
- Drive round obstacles.
- Never drive on the edge of a ditch or steep slope.
- It is dangerous to use two lift trucks simultaneously to handle heavy or bulky loads, since this operation requires particular precautions to be taken. It must only be used exceptionally and after risk analysis.
- The ignition switch has an emergency stop mechanism in case of an operating anomaly occurring in the case of lift trucks not fitted with a punch-operated cut-out.

#### INSTRUCTIONS

- Always drive the lift truck with the forks or attachment to the transport position, i.e. at 300 mm from the ground, the boom retracted and the carriage sloping backwards.
- For lift trucks with gearboxes, use the recommended gear (see: 2 - DESCRIPTION: INSTRUMENTS AND CONTROLS).
- Select the steering mode appropriate for its use and/or working conditions (see: 2 - DESCRIPTION: INSTRUMENTS AND CONTROLS) (as model of lift truck).
- Release the hand brake.
- Shift the forward/reverse selector to the selected direction of travel and accelerate gradually until the lift truck moves off.

#### **⚠ IMPORTANT ⚠**

- Starting and driving a lift truck on a slope can present a very real danger.*
- The lift truck being parked or stopped, scrupulously follow the following instructions for moving off:*
- Press the service brake pedal.
  - Engage 1st or 2nd gear and select forward or reverse.
  - Check that there is nothing and no-one obstructing the lift truck's path.
  - Release the service brake pedal and increase the engine revs.
- The risk is increased if the lift truck is laden or towing a trailer, requiring extreme vigilance.*

#### **G - STOPPING THE LIFT TRUCK**

##### SAFETY INSTRUCTIONS

- Never leave the ignition key in the lift truck during the operator's absence.
- When the lift truck is stationary, or if the operator has to leave his cab (even for a moment), place the forks or attachment on the ground, apply the parking brake and place the forward/reverse selector in neutral.
- Make sure that the lift truck is not stopped in any position that will interfere with the traffic flow and at less than one meter from the track of a railway.
- In the event of prolonged parking on a site, protect the lift truck from bad weather, particularly from frost (check the level of antifreeze), close and lock all the lift truck accesses (doors, windows, cowls, etc.).

##### INSTRUCTIONS

- Park the lift truck on flat ground or on an incline lower than 15 %.
- Set the forward/reverse selector to neutral.
- Engage the parking brake.
- For lift trucks with gearboxes, place the gear lever in neutral.
- Fully retract the boom.
- Lower the forks or attachment to rest on the ground.
- When using an attachment with a grab or jaws, or a bucket with hydraulic opening, close the attachment fully.
- Before stopping the lift truck after a long working period, leave the engine idling for a few moments, to allow the coolant liquid and oil to lower the temperature of the engine and transmission. Do not forget this precaution, in the event of frequent stops or warm stalling of the engine, or else the temperature of certain parts will rise significantly due to the stopping of the cooling system, with the risk of badly damaging such parts.
- Stop the engine with the ignition switch.
- Remove the ignition key.
- Lock all the accesses to the lift truck (doors, windows, cowls...).

## H - DRIVING THE LIFT TRUCK ON THE PUBLIC HIGHWAY

(or see current legislation in other countries)

### FRENCH ROAD TRAFFIC RULES

- The driving of non EC type-approved tractors on the public highway is subject to the provisions of the highway code relating to special machines, defined in article R311-1 of the highway code, in category B of the Equipment Order of 20 November 1969 that determines the procedures applicable to special machines. The lift truck must be fitted with a licence plate.
- The driving of EC type-approved tractors on the public highway is subject to the provisions of the highway code regarding agricultural tractors, defined in article R311-1 of the highway code. The lift truck must be registered.
- The lift truck must be driven on the public highway in accordance with the instructions given in the manual supplied with the lift truck (Gross weight, Gross combination weight, towing load, axle loads, maximum speeds, etc. according to type/version). The operator must be in possession of the lift truck's registration document.
- The operator must hold an HGV licence, unless granted an exemption.
- When towing a trailer or agricultural equipment, the travelling speed of the lift truck is limited to 25 km/h. In this case, a "25" disc must be affixed to the rear of the convoy. When driving with a trailer, the fact of not engaging 4th gear will ensure compliance with the towing speed limit (max. 25 km/h). On "POWERSHIFT" models, as 3rd gear is slower than on other models, it is preferable to use 5th gear and disable automatic upshifting to 6th gear (see: 2 - DESCRIPTION: INSTRUMENTS AND CONTROLS).

### SAFETY INSTRUCTIONS

- Operators driving on the public highway must comply with current highway code legislation.
- The lift truck must comply with current road legislation. If necessary, there are optional solutions. Contact your dealer.

### INSTRUCTIONS

- Make sure the revolving light is in place, switch it on and verify its operation.
- Make sure the lights, indicators and windscreen wipers are working properly.
- Switch off the working headlights if the lift truck is fitted with them.
- Select the steering mode "HIGHWAY TRAFFIC" (as model of lift truck) (see: 2 - DESCRIPTION: INSTRUMENTS AND CONTROLS).
- Fully retract the boom and set the attachment approximately 300 mm off the ground.
- Place the roll corrector in the central position, i.e. the transverse axis of the axles parallel to the chassis (as model of lift truck).
- Fully raise the stabilizers and turn the blocks inwards (according to model of lift truck).

#### **⚠ IMPORTANT ⚠**

*Never coast in neutral (forward/reverse selector or gear lever in neutral or transmission cut-off button pressed) to preserve the lift truck engine brake. Failure to observe this instruction on a slope will lead to excessive speed which may make the lift truck uncontrollable (steering, brakes) and cause serious mechanical damage.*

### DRIVING THE LIFT TRUCK WITH A FRONT-MOUNTED ATTACHMENT

- You must comply with current regulations in your country, covering the possibility of driving on the public highway with a front-mounted attachment on your lift truck.
- If road legislation in your country authorizes circulation with a front-mounted attachment, you must at least:
  - Protect and report any sharp and/or dangerous edges on the attachment (see: 4 - ADAPTABLE ATTACHMENTS IN OPTION ON THE RANGE: ATTACHMENT SHIELDS).
  - The attachment must not be loaded.
  - Make sure that the attachment does not mask the lighting range of the forward lights.
  - Make sure that current legislation in your country does not require other obligations.

### OPERATING THE LIFT TRUCK WITH A TRAILER

- For using a trailer, observe the regulations in force in your country (maximum travel speed, braking, maximum weight of trailer, etc.).
- Do not forget to connect the trailer's electrical equipment to that of the lift truck.
- The trailer's braking system must comply with current legislation.
- If pulling a trailer with assisted braking, the tractor lift truck must be equipped with a trailer braking mechanism. In this case, do not forget to connect the trailer braking equipment to the lift truck.
- The vertical force on the towing hook must not exceed the maximum authorised by the manufacturer (consult the manufacturer's plate on your lift truck).
- The authorised gross vehicle weight must not exceed the maximum weight authorised by the manufacturer (see: 2 - DESCRIPTION: CHARACTERISTICS).

**IF NECESSARY, CONSULT YOUR DEALER.**



## INSTRUCTIONS FOR HANDLING A LOAD

### A - CHOICE OF ATTACHMENTS

- Only attachments approved by MANITOU can be used on its lift trucks.
- Make sure the attachment is appropriate for the work to be done (see: 4 - ADAPTABLE ATTACHMENTS IN OPTION ON THE RANGE).
- If the lift truck is equipped with the Single side-shift carriage OPTION (TSDL), use only the authorised attachments (see: 4 - ADAPTABLE ATTACHMENTS IN OPTION ON THE RANGE).
- Make sure the attachment is correctly installed and locked onto the lift truck carriage.
- Make sure that your lift truck attachments work properly.
- Comply with the load chart limits for the lift truck for the attachment used.
- Do not exceed the rated capacity of the attachment.
- Never lift a load in a sling without the attachment provided for the purpose, as the sling risks to slip (see: INSTRUCTIONS FOR HANDLING A LOAD: H - TAKING UP AND LAYING DOWN A SUSPENDED LOAD).
- Do not handle loads that are hung directly from the forks with straps (e.g.: big-bag), as there is a risk that the straps will shear against the sharp edges. Use an attachment designed for this purpose.

### B - MASS OF LOAD AND CENTRE OF GRAVITY

- Before taking up a load, you must know its mass and its centre of gravity.
- The load chart for your lift truck is valid for a load in which the longitudinal position of the centre of gravity is 500 mm from the base of the forks (fig. B1). For a higher centre of gravity, contact your dealer.
- For irregular loads, determine the transverse centre of gravity before any movement (fig. B2) and set it in the longitudinal axis of the lift truck.

#### ⚠ IMPORTANT ⚠

*It is forbidden to move a load heavier than the effective capacity defined on the lift truck load chart.  
For loads with a moving centre of gravity (e.g. liquids), take account of the variations in the centre of gravity in order to determine the load to be handled and be vigilant and take extra care to limit these variations as far as possible.*

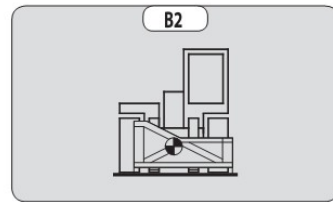
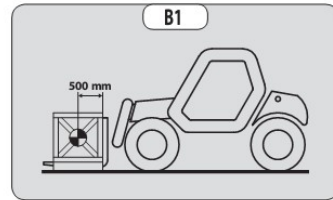

### C - LONGITUDINAL STABILITY LIMITER AND WARNING DEVICE

This device gives an indication of the longitudinal stability of the lift truck, and limits hydraulic movements in order to ensure this stability, at least under the following operating conditions:

- when the lift truck is at a standstill,
  - when the lift truck is on firm, stable and consolidated ground,
  - when the lift truck is performing handling and placing operations.
- Move the jib very carefully when approaching the authorized load limit (see: 2 - DESCRIPTION: INSTRUMENTS AND CONTROLS).
  - Always watch this device during handling operations.
  - In the event that "AGGRAVATING" hydraulic movements are cut-off, only perform de-aggravating hydraulic movements in the following order (fig. C): if necessary, raise the jib (1), retract the jib as far as possible (2) and lower the jib (3) to set down the load.

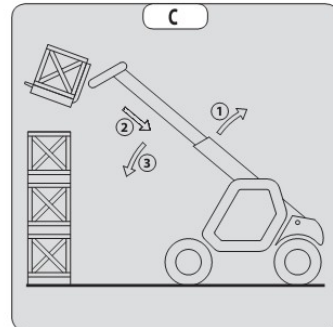

#### ⚠ IMPORTANT ⚠

*The instrument reading may be erroneous when the steering is at full lock or the rear axle is oscillated to its maximum extent.  
Before lifting a load, make sure that the lift truck is not in either of these situations.*

## D - TRANSVERSE ATTITUDE OF THE LIFT TRUCK

Depending on the model of lift truck

The transverse attitude is the transverse slope of the chassis with respect to the horizontal.

Raising the jib reduces the lift truck's lateral stability. The transverse attitude must be set with the jib in down position as follows:

### 1 - LIFT TRUCK WITHOUT ROLL CORRECTOR USED ON TYRES

- Position the lift truck so that the bubble in the level is between the two lines (see: 2 - DESCRIPTION: INSTRUMENTS AND CONTROLS).

### 2 - LIFT TRUCK WITH ROLL CORRECTOR USED ON TYRES

- Correct the roll using the hydraulic control and check horizontality with the spirit level. The bubble in the level must be between the two lines (see: 2 - DESCRIPTION: INSTRUMENTS AND CONTROLS).

### 3 - LIFT TRUCK USED ON STABILIZERS

- Set the two stabilizers on the ground and raise the two front wheels of the lift truck (fig. D1).
- Correct the roll using the stabilizers (fig. D2) and check horizontality with the spirit level. The bubble of the level must be between the two lines (see: 2 - DESCRIPTION: INSTRUMENTS AND CONTROLS). In this position, the two front wheels must be off the ground.

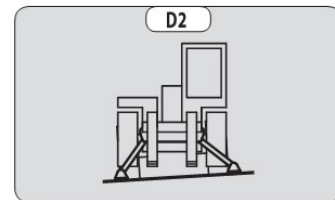
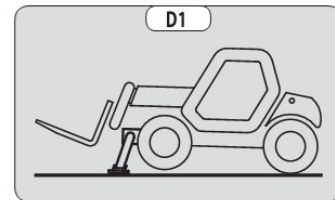

## E - TAKING UP A LOAD ON THE GROUND

- Approach the lift truck perpendicular to the load, with the jib retracted and the forks in a horizontal position (fig. E1).
- Adjust the fork spread and centring relative to the load to ensure stability (fig. E2) (optional solutions exist, consult your dealer).
- Never lift a load with a single fork.

### ⚠ IMPORTANT ⚠

*Beware of the risks of trapping or squashing limbs when manually adjusting the forks.*

- Move the lift truck forward slowly (1) and insert the forks under the load as far as they will go (fig. E3). If necessary, slightly lift the jib (2) while taking up the load.
- Bring the load into the transport position.
- Tilt the load far enough backwards to ensure stability (loss of load on braking or going downhill).

### FOR A NON-PALLETISED LOAD

- Tilt the carriage (1) forwards and move the lift truck slowly forwards (2), to insert the fork under the load (fig. E4) (block the load if necessary).
- Continue to move the lift truck forwards (2) tilting the carriage (3) (fig. E4) backwards to position the load on the forks and check the load's longitudinal and lateral stability.

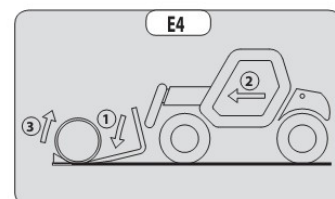
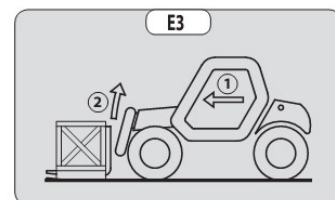
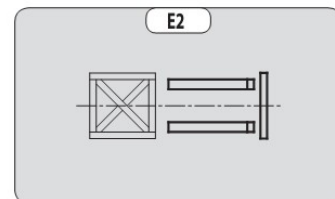
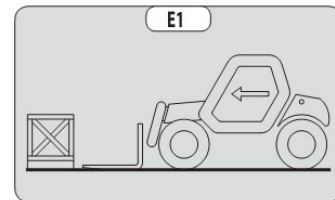

## F - TAKING UP AND LAYING A HIGH LOAD ON TYRES

### ⚠ IMPORTANT ⚠

*You must not raise the jib if you have not checked the transverse attitude of the lift truck (see: INSTRUCTIONS FOR HANDLING A LOAD: D - TRANSVERSE ATTITUDE OF THE LIFT TRUCK).*

REMINDER: Make sure that the following operations can be performed with good visibility (see: OPERATIONS INSTRUCTIONS UNLADEN AND LADEN: D - VISIBILITY).

### TAKING UP A HIGH LOAD ON TYRES

- Ensure that the forks will easily pass under the load.
- Lift and extend the jib (1) (2) until the forks are level with the load, moving the lift truck (3) forward if necessary (fig. F1), moving very slowly and carefully.
- Always remember to keep the distance necessary for inserting the forks under the load, between the stack and the lift truck (fig. F1) and use the shortest possible length of jib.
- Insert the forks under the load as far as they will go by alternately extending and lowering the jib (1) or, if necessary, moving the lift truck forward (2) (fig. F2). Apply the handbrake and place the forward/reverse selector in neutral.
- Slightly raise the load (1) and tilt the carriage (2) backwards to stabilize the load (fig. F3).
- Tilt the load sufficiently backwards to ensure its stability.
- Monitor the longitudinal stability limiter and warning device (see: INSTRUCTIONS FOR HANDLING A LOAD: C - LONGITUDINAL STABILITY LIMITER AND WARNING DEVICE). If it is overloaded, set the load back down in the place from which it was taken.
- If possible lower the load without shifting the lift truck. Lift the jib (1) to release the load, retract (2) and lower the jib (3) to bring the load into the transport position (fig. F4).
- If this is not possible, back up the lift truck (1), manoeuvring very gently and carefully to release the load. Retract (2) and lower the jib (3) to bring the load into the transport position (fig. F5).

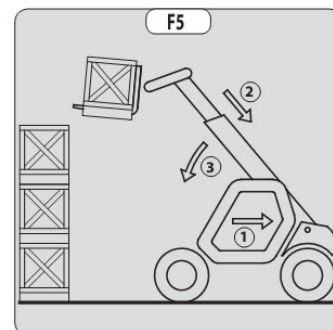
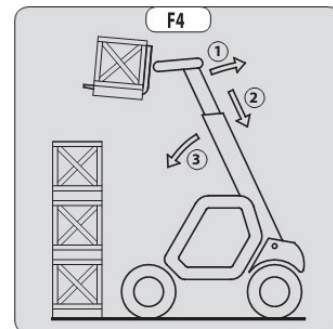
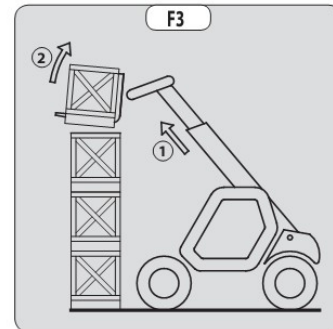
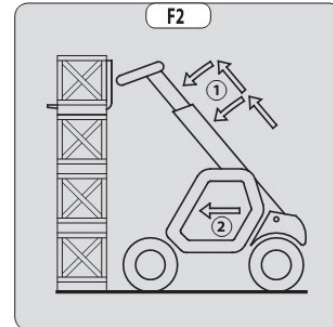
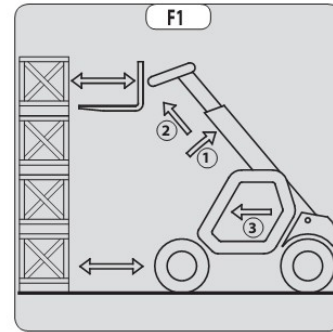

647511 (09/09/2016)  
MT 625 H E6SY 49 K3B3A S1

## LAYING A HIGH LOAD ON TYRES

- Approach the load in the transport position in front of the stack (fig. F6).
- Apply the parking brake and place the forward/reverse selector in neutral.
- Raise and extend the jib (1) (2) until the load is above the stack, while monitoring the longitudinal stability limiter and warning device (see: INSTRUCTIONS FOR HANDLING A LOAD: C - LONGITUDINAL STABILITY LIMITER AND WARNING DEVICE). If necessary, move the lift truck (3) forward (fig. F7), driving very slowly and carefully.
- Place the load in a horizontal position and lay it down on the pile by lowering and retracting the jib (1) (2) in order to position the load correctly (fig. F8).
- If possible, release the fork by alternately retracting and raising the jib (1) (fig. F9). Then set the forks into transport position.
- If this is not possible, reverse the lift truck (1) very slowly and carefully to release the forks (fig. F10). Then set them into transport position.

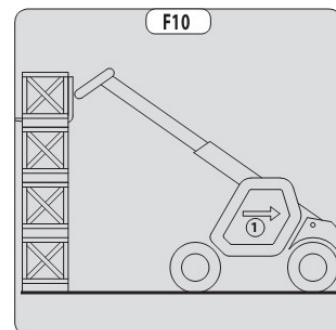
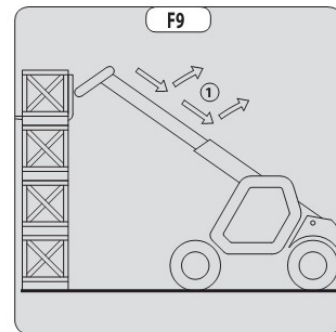
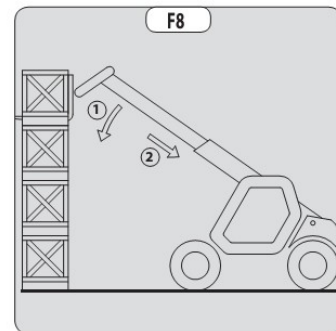
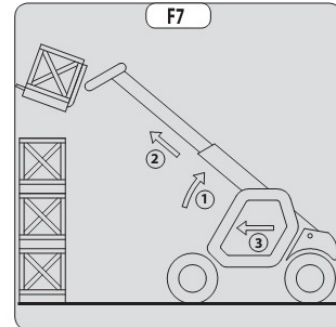
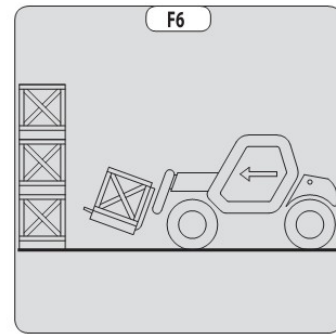

647511 (09/09/2016)  
MT 625 H EASY 49 K33A S1

## G - TAKING UP AND LAYING A HIGH LOAD ON STABILIZERS

Depending on the model of lift truck

### ⚠ IMPORTANT ⚠

*You must not raise the jib if you have not checked the transverse attitude of the lift truck (see: INSTRUCTIONS FOR HANDLING A LOAD: D - TRANSVERSE ATTITUDE OF THE LIFT TRUCK).*

REMINDER: Make sure that the following operations can be performed with good visibility (see: OPERATIONS INSTRUCTIONS UNLADEN AND LADEN: D - VISIBILITY).

The stabilizers are used to optimise the lift truck's lifting performances (see: 2 - DESCRIPTION: INSTRUMENTS AND CONTROLS).

POSITION THE STABILIZERS WITH THE FORKS IN TRANSPORT POSITION (UNLADEN AND LADEN)

- Set the forks in transport position in front of the elevation.
- Stay far enough away to have room for the jib to be raised.
- Apply the parking brake and place the forward/reverse selector in neutral.
- Set the two stabilizers on the ground and lift the two front wheels of the lift truck (fig. G1), while maintaining its transverse stability.

RAISE THE STABILIZERS WITH THE FORKS IN TRANSPORT POSITION (UNLADEN AND LADEN)

- Raise both stabilizers fully and at the same time.

LOWERING OF STABILISERS WITH JIB UP (UNLADEN AND LADEN).

### ⚠ IMPORTANT ⚠

*This operation must be exceptional and performed with great care.*

- Raise the jib and retract the telescopes completely.
- Set the lift truck in position in front of the elevation (fig. G2) moving very slowly and carefully.
- Apply the parking brake and place the forward/reverse selector in neutral.
- Move the stabilizers very slowly and gradually as soon as they are close to the ground or in contact with it.
- Lower the two stabilizers and lift the two front wheels of the lift truck (fig. G3). During this operation, transverse attitude must be permanently maintained: the bubble in the level must be kept between the two lines.

SETTING THE STABILIZERS WITH THE JIB UP (UNLADEN AND LADEN)

### ⚠ IMPORTANT ⚠

*This operation must be exceptional and performed with great care.*

- Keep the jib up and retract the telescopes completely (fig. G3).
- Move the stabilizers very slowly and gradually as soon as they are in contact with the ground and when they leave the ground. During this operation, the transverse attitude must be permanently maintained: the bubble in the level must be kept between the two lines.
- Raise both stabilizers completely.
- Release the parking brake and reverse the lift truck (1) very slowly and carefully, to release it and lower the forks (2) into transport position (fig. G4).

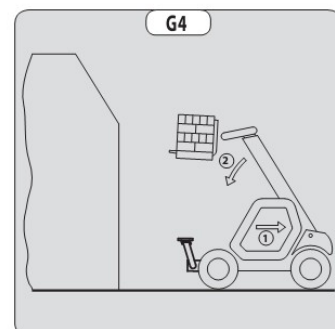
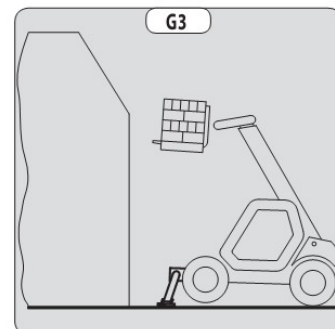
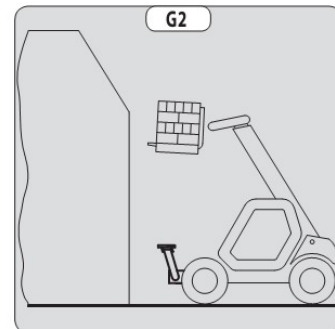
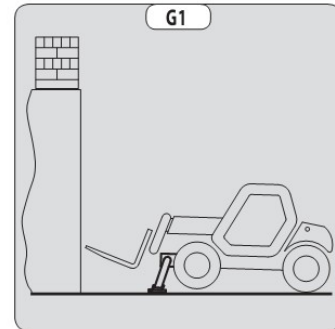

### TAKING UP A HIGH LOAD ON STABILISERS

- Ensure that the forks will easily pass under the load.
- Check the position of the lift truck with respect to the load and make a test run, if necessary, without taking the load.
- Raise and extend the jib (1) (2) until the forks are at the level of the load (fig. G5).
- Insert the forks under the load as far as they will go by alternately extending and lowering the jib (1) (fig. G6).
- Lift the load slightly (1) and tilt the carriage (2) backwards to stabilise the load (fig. G7).
- Monitor the longitudinal stability limiter and warning device (see: INSTRUCTIONS FOR HANDLING A LOAD: C - LONGITUDINAL STABILITY LIMITER AND WARNING DEVICE). If it is overloaded, set the load back down in the place from which it was taken.
- If possible lower the load without moving the lift truck. Raise the jib (1) to release the load, retract (2) and lower the jib (3) to set the load into transport position (fig. G8).

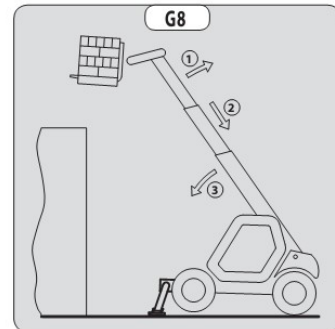
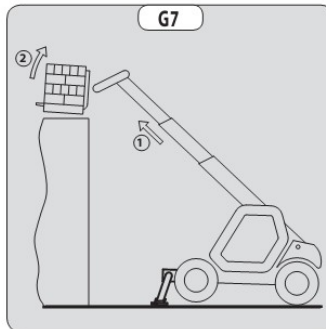
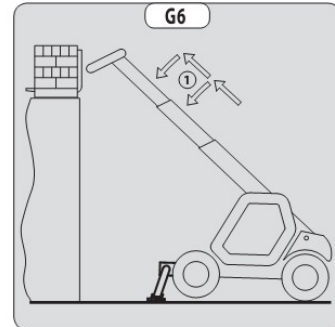
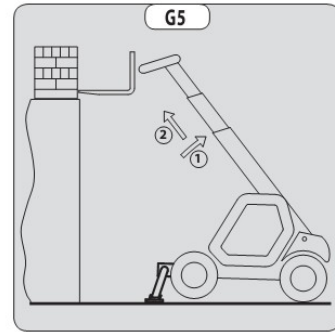

### LAYING A HIGH LOAD ON STABILISERS

- Raise and extend the jib (1) (2) until the load is above the elevation (fig. G9), while monitoring the longitudinal stability limiter and warning device (see: INSTRUCTIONS FOR HANDLING A LOAD: C - LONGITUDINAL STABILITY LIMITER AND WARNING DEVICE).
- Position the load horizontally and release it by lowering and retracting the jib (1) (2) to position the load correctly (fig. G10).
- Free the forks by alternating retracting and raising the jib (3) (fig. G11).
- If possible, set the jib in transport position without moving the lift truck.

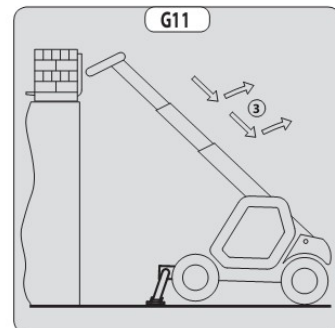
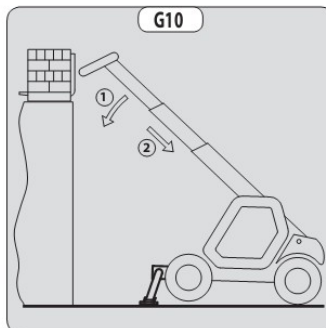
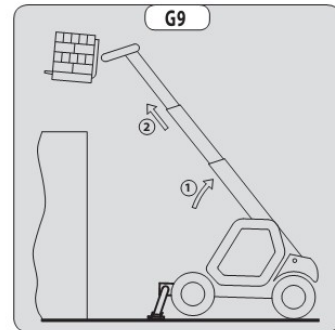

## H - TAKING UP AND LAYING DOWN A SUSPENDED LOAD

### **⚠ IMPORTANT ⚠**

*Failure to follow the above instructions may lead the lift truck to loose stability and overturn.  
MUST be used with a lift truck equipped with an operational hydraulic movement cut-out device.*

#### CONDITIONS OF USE

- The length of the sling or the chain shall be as short as possible to limit swinging of the load.
- Lift the load vertically along its axis, never by pulling sideways or lengthways.

#### HANDLING WITHOUT MOVING THE LIFT TRUCK

- Whether on stabilisers or on tyres, the lateral attitude must not exceed 1 % and the longitudinal attitude must not exceed 5%, the bubble of the level must be held at "0".
- Ensure that the wind speed is not higher than 10 m/s.
- Ensure that there is no one between the load and the lift truck.

#### I - TRAVELLING WITH A SUSPENDED LOAD

- Before moving, inspect the terrain in order to avoid excessive slopes and cross-falls, bumps and potholes, or soft ground.
- Ensure that the wind speed is not higher than 36 km/h.
- The lift truck must not travel at more than 0,4 m/s (1,5 km/h, i.e., one quarter walking speed).
- Drive and stop the lift truck gently and smoothly to minimise swinging of the load.
- Carry the load a few centimetres above the ground (max. 30 cm) the shortest possible jib length. Do not exceed the offset indicated on the load chart. If the load begins to swing excessively, do not hesitate to stop and lower the jib to set down the load.
- Before moving the lift truck, check the longitudinal stability limiter and warning device (see: 2 - DESCRIPTION: INSTRUMENTS AND CONTROLS), only the green LEDs and possible the yellow LEDs should be lit.
- During transport, the lift truck operator must be assisted by a person on the ground (standing a minimum of 3 m from the load), who will limit swinging of the load using a bar or a rope. Ensure that this person is always clearly in view.
- The lateral attitude must not exceed 5 %, the bubble in the level must be kept between the two "MAX" marks
- The longitudinal attitude must not exceed 15 %, with the load facing uphill, and 10%, with the load facing downhill.
- The jib angle must not exceed 45°.
- If the first red LED of longitudinal stability limiter and warning device (see: 2 - DESCRIPTION: INSTRUMENTS AND CONTROLS) comes on while travelling, gently bring the lift truck to a halt and stabilise the load. Retract the telescope to reduce the offset of the load.

## PLATFORM OPERATING INSTRUCTIONS

For lift trucks fitted with a PLATFORM

### A - AUTHORISATION FOR USE

- Operation of the platform requires further authorisation in addition to that of the lift truck.

### B - LIFT TRUCK SUITABILITY FOR USE

- MANITOU has ensured that this platform is suitable for use under the normal operating conditions defined in this operator's manual, with a **STATIC** test coefficient **OF 1,25** and a **DYNAMIC** test coefficient **OF 1,1**, as specified in harmonised standard **EN 280** for "mobile elevating work platforms".
- Before commissioning, the company manager must make sure that platform is appropriate for the work to be done, and perform certain tests (in accordance with current legislation).

### C - PRECAUTIONS WHEN USING THE PLATFORM

- Wear suitable clothing when using the platform, avoid loosely-fitting garments.
- Never operate the platform when hands or feet are wet or soiled with greasy substances.
- Remain alert at all times when using the platform. Do not listen to the radio or music using headphones or earphones.
- For increased comfort, adopt the correct position at the platform's operator station.
- The platform's guard rail exempts the operator from wearing a safety harness under normal operating conditions. As a result, you are responsible for deciding whether to wear a safety harness.
- The control units must never in any event be used for any other than their intended purposes (e.g. climbing onto or down from the lift truck, portmanteau, etc.).
- Safety helmets must be worn.
- The operator must always be in the normal operator's position. It is prohibited to have arms or legs, or generally any part of the body, protruding from the basket.
- Ensure that any materials loaded onto the platform (pipes, cables, containers, etc.) cannot fall out. Do not pile these materials to the point where it is necessary to step over them.

### D - USING THE PLATFORM

- However experienced they may be, operators must acquaint themselves with the emplacement and operation of all control instruments prior to operating the platform.
- Check before use that the platform has been correctly assembled and locked onto the lift truck.
- Check before operating the platform that the access gate has been properly locked.
- The platform should be operated in an area free of any obstructions or danger when it is lowered to the ground.
- The operator using the platform must be aided on the ground by a person with adequate training.
- You should stay within the limits set out in the platform load chart.
- The lateral stresses are limited pressure (see: 2 - DESCRIPTION: CHARACTERISTICS).
- It is strictly forbidden to hang a load from the platform or the lift truck jib without a specially designed attachment (see: INSTRUCTIONS FOR HANDLING A LOAD: H - TAKING UP AND LAYING DOWN A SUSPENDED LOAD).
- The platform cannot be used as a crane or a lift for permanently transporting people or materials, nor as jacks or supports.
- The lift truck must not be moved with one (or more) person(s) in the platform.
- It is forbidden to transport people on the platform using the hydraulic controls in the lift truck's driver's cab (except in case of rescue).
- The operator must not climb onto to off the platform when it is not on ground level (jib retracted and in the down position).
- The platform must not be fitted with attachments that increase the unit's wind load.
- Do not use ladders or improvised structures in the platform to gain extra height.
- Do not climb onto the sides of the platform to gain extra height.
- It is forbidden to use the platform on forks. The fork slots are only to, be used for storing the platform and not for lifting people under any circumstances.

### E - ENVIRONMENT



*It is forbidden to use the platform close to electricity cables. Maintain the specified safe distances.*

RATED VOLTAGE	DISTANCE ABOVE GROUND OR FLOOR IN METRES
50 < U < 1000	2,30 M
1000 < U < 30000	2,50 M
30000 < U < 45000	2,60 M
45000 < U < 63000	2,80 M
63000 < U < 90000	3,00 M
90000 < U < 150000	3,40 M
150000 < U < 225000	4,00 M
225000 < U < 400000	5,30 M
400000 < U < 750000	7,90 M

647511 (09/09/2016)  
MT 625 H E6SY 49 K3BA 5T



**⚠ IMPORTANT ⚠**

*It is strictly forbidden to use the platform when the wind speed exceeds 45 km/h.*

- To visually recognise this wind speed, refer to the empirical wind evaluation scale below:

BEAUFORT scale (wind speed at a height of 10 m on a flat site)						
Force	Type of wind	Speed (knots)	Speed (km/h)	Speed (m/s)	Effects on Land	Sea conditions
0	Calm	0 - 1	0 - 1	< 0,3	- Smoke rises vertically.	- Sea is like a mirror.
1	Light air	1 - 3	1 - 5	0,3 - 1,5	- Smoke indicates direction of wind.	- Ripples with appearance of scale, no foam crests.
2	Light breeze	4 - 6	6 - 11	1,6 - 3,3	- Wind felt on face, leaves rustle.	- Short wavelets, but pronounced.
3	Gentle breeze	7 - 10	12 - 19	3,4 - 5,4	- Leaves and small twigs in constant motion.	- Very small waves, crests begin to break.
4	Moderate breeze	11 - 16	20 - 28	5,5 - 7,9	- Wind raises dust and loose pieces of paper; small branches are moved.	- Small waves, becoming longer, numerous whitecaps.
5	Fresh breeze	17 - 21	29 - 38	8 - 10,7	- Small trees in leaf begin to sway.	- Wavelets form on inland waters; moderate waves, taking longer form.
6	Strong breeze	22 - 27	39 - 49	10,8 - 13,8	- Large branches in motion, whistling heard in overhead wires, umbrella use becomes difficult.	- Larger waves forming, whitecaps everywhere, some spray.
7	Near gale	28 - 33	50 - 61	13,9 - 17,1	- Whole trees in motion, inconvenience felt when walking against the wind.	- Sea heaps up; white foam from breaking waves begins to be blown in streaks along the direction of the wind.
8	Gale	34 - 40	62 - 74	17,2 - 20,7	- Wind breaks twigs off trees; impedes progress.	- Moderately high waves of greater length; edges of crests begin to break into spindrift.
9	Strong gale	41 - 47	75 - 88	20,8 - 24,4	- Wind damages roofs (chimneys, slates, etc.).	- High waves, crests of waves begin to topple, streaks of foam; reduced visibility.
10	Storm	48 - 55	89 - 102	24,5 - 28,4	- Seldom experienced inland; trees uprooted; considerable structural damage occurs.	- Very high waves; white streaks of foam; reduced visibility.
11	Violent storm	56 - 63	103 - 117	28,5 - 32,6	- Very rare, widespread damage.	- Exceptionally high waves able to hide medium sized ships from view, reduced visibility.
12	Hurricane	64 +	118 +	32,7 +	- Devastating damage.	- Sea completely white; air filled with foam and spray, very reduced visibility.

**F - MAINTENANCE**

**⚠ IMPORTANT ⚠**

*Your platform must be periodically inspected to ensure its continued compliance.*

*The inspection frequency is defined by the legislation applying in the country in which the platform is used.*

*In France, a general periodic inspection every 6 months (order of 1 March 2004).*

## INSTRUCTIONS FOR USING THE RADIO-CONTROL

For lift trucks with RC radio control

### HOW TO USE THE RADIO-CONTROL

#### SAFETY INSTRUCTIONS

- This radio-control consists of electronic and mechanical safety elements. It cannot receive commands from another transmitter because the internal encoding is unique to each radio-control.

#### **⚠ IMPORTANT ⚠**

*If it is used improperly or incorrectly, there is a risk of danger to:*

- *The physical and mental health of the user or others.*
- *The lift truck and other neighbouring items.*

*All those working with this radio-control:*

- *Must be qualified in line with current regulations and trained accordingly.*
- *Must follow this instruction manual as closely as possible.*

- The system is used to control the lift truck remotely via radio waves. Commands are also transmitted if the lift truck is out of sight (behind an obstacle or a building for example), this is why:
  - After stopping the truck and removing the key switch (only possible when it is stationary), always place the transmitter in a safe, dry place.
  - Before performing any installation, servicing or repair work, always switch off power sources (in particular, electric welding devices and electric head units on hydraulic distributors must be disconnected at each section).
  - Never remove or alter the safety devices (such as the hand-guard frame, key, emergency stop button, etc.).

#### **⚠ IMPORTANT ⚠**

*Never drive the lift truck if it is not continuously and perfectly within view of the operator!*

- Before leaving the transmitter, the operator must make sure that it cannot be used by an unauthorized third person: either by removing the key button from the transmitter or locking it in an inaccessible place.
- The user must ensure that the instruction manual is accessible at all times and that operators have read and understood it.

#### INSTRUCTIONS

- Take up position in a stable place with no risk of slipping.
- Before using the transmitter, make sure there is nobody within the working area.
- Only use the transmitter with its carrying device or installed correctly on the platform.

#### **⚠ IMPORTANT ⚠**

*When you remove the transmitter, remove the accumulator and key button so that it cannot be used accidentally or deliberately by anyone else.*

#### PROTECTIVE DEVICES

- The lift truck will be immobilised within a maximum of 450 milliseconds (approx. 0.5 second):
  - If the emergency stop button of the transmitter is pressed (50 milliseconds), or that of the lift truck.
  - If the transmission distance of the radio waves is exceeded.
  - If the transmitter is faulty.
  - If an interfering radio signal is received from elsewhere.
  - If the accumulator is removed from its housing in the transmitter.
  - If the battery reaches the end of its autonomy.
  - If the transmitter is switched off by turning the key switch to the off position.
- These protective devices are provided for the safety of personnel and property and must never be altered, removed or bypassed in any way whatsoever!
- The hand-guard frame prevents external action on a manipulator (e.g. if the transmitter is dropped, or if the operator leans on a guard-rail).
- An electronic safety device prevents radio transmission from being initiated if the manipulators are not mechanically and electrically at rest and if the internal combustion engine speed selector is not set to idle.

#### **⚠ IMPORTANT ⚠**

*In an emergency, press the transmitter emergency stop button immediately; then follow the manual's instructions (see: 2- DESCRIPTION: INSTRUMENTS AND CONTROLS).*

# LIFT TRUCK MAINTENANCE INSTRUCTIONS

## GENERAL INSTRUCTIONS

- Ensure the area is sufficiently ventilated before starting the lift truck.
- Wear clothes suitable for the maintenance of the lift truck, avoid wearing jewellery and loose clothes. Tie and protect your hair, if necessary.
- Stop the engine and remove the ignition key, when an intervention is necessary.
- Read the operator's manual carefully.
- Carry out all repairs immediately, even if the repairs concerned are minor.
- Repair all leaks immediately, even if the leak concerned is minor.
- Make sure that the disposal of process materials and of spare parts is carried out in total safety and in a ecological way.
- Be careful of the risk of burning and splashing (exhaust, radiator, engine, etc.).

## PLACING THE JIB SAFETY WEDGE

- The lift truck is equipped with a jib safety wedge (see: 2 - DESCRIPTION: INSTRUMENTS AND CONTROLS) that must be installed on the rod of the lifting cylinder when working beneath the jib.

### FITTING THE WEDGE

- Fully raise the jib.
- Place the safety wedge 1 on the rod of the lifting cylinder and secure with the rod 2 and the pin 3.
- Slowly lower the jib then stop the hydraulic movements before it comes into contact with the wedge.

### REMOVING THE WEDGE

- Fully raise the jib.
- Remove the pin and the rod.
- Return the safety wedge to the storage location provided on the lift truck.

**⚠ IMPORTANT ⚠**

*Only use the wedge supplied with the lift truck.*

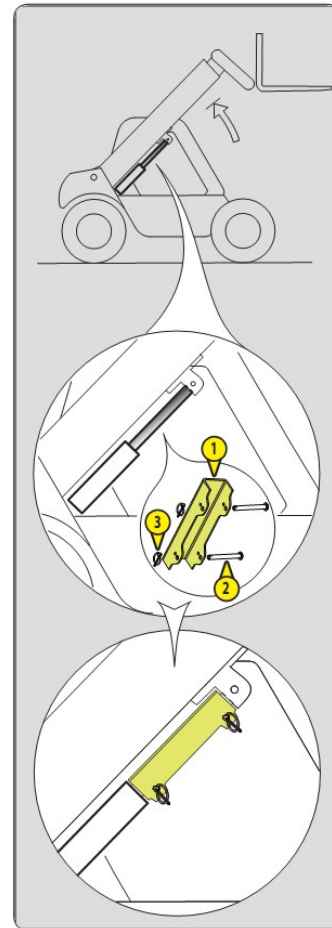

## MAINTENANCE

- Perform the periodic service (see: 3 - MAINTENANCE) to keep your lift truck in good working conditions. Failure to perform the periodic service may cancel the contractual guarantee.

### MAINTENANCE LOGBOOK

- The maintenance operations carried out in accordance with the recommendations given in part: 3 - MAINTENANCE and the other inspection, servicing or repair operations or modifications performed on the lift truck or its attachments shall be recorded in a maintenance logbook. The entry for each operation shall include details of the date of the works, the names of the individuals or companies having performed them, the type of operation and its frequency, if applicable. The part numbers of any lift truck items replaced shall also be indicated.

## LUBRICANT AND FUEL LEVELS

---

- Use the recommended lubricants (never use contaminated lubricants).
- Do not fill the fuel tank when the engine is running.
- Only fill up the fuel tank in areas specified for this purpose.
- Do not fill the fuel tank to the maximum level.
- Do not smoke or approach the lift truck with a flame, when the fuel tank is open or is being filled.

## HYDRAULIC

---

- Any work on the load handling hydraulic circuit is forbidden except for the operations described in part: 3 - MAINTENANCE.
- Do not attempt to loosen unions, hoses or any hydraulic component with the circuit under pressure.

### **IMPORTANT**

*BALANCING VALVE: It is dangerous to change the setting and remove the balancing valves or safety valves which may be fitted to your lift truck cylinders. The HYDRAULIC ACCUMULATORS that may be fitted on your lift truck are pressurised units. Removing these accumulators and their pipework is a dangerous operation and must only be performed by approved personnel (consult your dealer).*

## ELECTRICITY

---

- Do not short-circuit the starter relay to start the engine. If the forward/reverse selector is not in neutral and the parking brake is not applied, the lift truck may suddenly start to move.
- Do not drop metallic items on the battery.
- Disconnect the battery before working on the electrical circuit.

## WELDING

---

- Disconnect the battery before any welding operations on the lift truck.
- When carrying out electric welding work on the lift truck, connect the negative cable from the equipment directly to the part being welded, so as to avoid high tension current passing through the alternator.
- Never carry out welding or work which gives off heat on an assembled tyre. The heat would increase the pressure which could cause the tyre to explode.
- If the lift truck is equipped with an electronic control unit, disconnect this before starting to weld, to avoid the risk of causing irreparable damage to electronic components.

## WASHING THE LIFT TRUCK

---

- Clean the lift truck or at least the area concerned before any intervention.
- Remember to close and lock all accesses to the lift truck (doors, windows, cowls...).
- During washing, avoid the articulations and electrical components and connections.
- If necessary, protect against penetration of water, steam or cleaning agents, components susceptible of being damaged, particularly electrical components and connections and the injection pump.
- Clean the lift truck of any fuel, oil or grease trace.

## TRANSPORTING THE LIFT TRUCK

---

### **IMPORTANT**

*Transporting the lift truck involves real risks for the operator and others involved.*

- Towing, slinging or transporting the lift truck (see: 3 - MAINTENANCE: G - OCCASIONAL MAINTENANCE).

## IF THE LIFT TRUCK IS NOT TO BE USED FOR A LONG TIME

### INTRODUCTION

The following recommendations are intended to prevent the lift truck from being damaged when it is withdrawn from service for an extended period.

#### **⚠ IMPORTANT ⚠**

*Procedures to follow if the lift truck is not to be used for a long time and for starting it up again afterwards must be performed by your dealership. This long-term storage period must not exceed 12 months.*

### PREPARING THE LIFT TRUCK

- Clean the lift truck thoroughly.
- Check and repair any fuel, oil, water or air leaks.
- Replace or repair any worn or damaged parts.
- Wash the painted surfaces of the lift truck in clear and cold water and wipe them.
- Touch up the paintwork if necessary.
- Shut down the lift truck (see: OPERATING INSTRUCTIONS UNLADEN AND LADEN).
- Make sure the jib cylinder rods are all in retracted position.
- Release the pressure in the hydraulic circuits.

### PROTECTING THE ENGINE

- Fill the tank with fuel (see: 3 - MAINTENANCE: A - DAILY OR EVERY 10 HOURS SERVICE).
- Empty and replace the cooling liquid (see: 3 - MAINTENANCE: F - EVERY 2000 HOURS SERVICE).
- Leave the engine running at idling speed for a few minutes, then switch off.
- Replace the engine oil and oil filter (see: 3 - MAINTENANCE: D - EVERY 500 HOURS SERVICE).
- Run the engine for a short time so that the oil and cooling liquid circulate inside.
- Disconnect the battery and store it in a safe place away from the cold, after charging it to a maximum.
- Block the outlet with waterproof adhesive tape.
- Remove the drive belts and store them in a safe place.
- Disconnect the engine cut-off solenoid on the injection pump and carefully insulate the connection.

### PROTECTING THE LIFT TRUCK

- Set the lift truck on axle stands so that the tires are not in contact with the ground and release the parking brake.
- Protect cylinder rods which will not be retracted, from corrosion.
- Wrap the tires.

NOTE: If the lift truck is to be stored outdoors, cover it with a waterproof tarpaulin.

### BRINGING THE LIFT TRUCK BACK INTO SERVICE

- Remove the waterproof adhesive tape from all the holes.
- Refit and reconnect the battery.
- Remove the protection from the cylinder rods.
- Perform the daily service (see: 3 - MAINTENANCE: A - DAILY OR EVERY 10 HOURS SERVICE).
- Put the handbrake on and remove the axle stands.
- Empty and replace the fuel and replace the fuel filter (see: 3 - MAINTENANCE: D - EVERY 500 HOURS SERVICE).
- Refit and set the tension in the drive belts (see: 3 - MAINTENANCE: FILTERS CARTRIDGES AND BELTS).
- Turn the engine over with the starter, to allow the oil pressure to rise.
- Reconnect the engine cut-off solenoid.
- Lubricate the lift truck completely (see: 3 - MAINTENANCE: SERVICING SCHEDULE).

#### **⚠ IMPORTANT ⚠**

*Ensure the area is sufficiently ventilated before starting the lift truck.*

- Start up the lift truck, following the safety instructions and regulations (see: OPERATING INSTRUCTIONS UNLADEN AND LADEN).
- Run all the jib's hydraulic movements, concentrating on the ends of travel for each cylinder.

## LIFT TRUCK DISPOSAL

MANITOU complies with the regulations deriving from Directive 2000/53/EC relating to lift truck end-of-life. This lift truck contains no substances or materials forbidden by Directive 2000/53/EC.

NOTE: Consult your dealer before disposing of your lift truck.

### RECYCLING OF MATERIALS

---

#### METALS

- Metals are 100 % recoverable and recyclable.

#### PLASTICS

- Plastic parts are identified with a marking in accordance with current regulations.
- A limited range of materials is used to simplify the recycling process.
- The majority of plastic components are made of "thermoplastic" plastics, that are easily recycled by melting, granulating or grinding.

#### RUBBER

- Tyres and seals can be ground for use in cement manufacture or to obtain reusable granules.

#### GLASS

- Glass items can be removed and collected for processing by glaziers.

### ENVIRONMENTAL PROTECTION

---

By entrusting the maintenance of your lift truck to the MANITOU network, the risk of pollution is limited and the contribution to environmental protection contribution is made.

#### WORN OR DAMAGED PARTS

- Do not dump them in the countryside.
- MANITOU and its network have signed-up to a scheme of environmental protection through recycling.

#### USED OIL

- The MANITOU network organises the collection and processing of used oil products.
- By handing over your waste oil to MANITOU, the risk of pollution is limited.

#### USED BATTERIES

- Do not throw away batteries, as they contain metals that are harmful for the environment.
- Return them to the MANITOU network or any other approved collection point.

NOTE: MANITOU aims to manufacture lift trucks that provide the best performance and limit polluting emissions.

# **2 - DESCRIPTION**

## TABLE OF CONTENTS

### 2 - DESCRIPTION

<u>«EC» DECLARATION OF CONFORMITY</u>	<u>4</u>
<u>SAFETY PLATES AND STICKERS</u>	<u>6</u>
<u>IDENTIFICATION OF THE LIFT TRUCK</u>	<u>10</u>
<u>CHARACTERISTICS</u>	<u>12</u>
<u>TIRES</u>	<u>14</u>
<u>DIMENSIONS AND LOAD CHART</u>	<u>16</u>
<u>VISIBILITY</u>	<u>18</u>
<u>INSTRUMENTS AND CONTROLS</u>	<u>20</u>
<u>TOWING PIN AND HOOK</u>	<u>42</u>
<u>DESCRIPTION AND USE OF THE OPTIONS</u>	<u>44</u>



1) **DÉCLARATION «CE» DE CONFORMITÉ (originale)**  
*«EC» DECLARATION OF CONFORMITY (original)*

2) La société, *The company* : **MANITOU BF**

3) Adresse, *Address* : **430, rue de l'Aubinière - BP 10249 - 44158 - ANCENIS CEDEX - FRANCE**

4) Dossier technique, *Technical file* : **MANITOU BF - 430, rue de l'Aubinière  
BP 10249 - 44158 - ANCENIS CEDEX - FRANCE**

5) Constructeur de la machine décrite ci-après, *Manufacturer of the machine described below* :

**MT 625 H EASY 49K ST3A S1**

6) Déclare que cette machine, *Declares that this machine* :

7) Est conforme aux directives suivantes et à leurs transpositions en droit national,  
*Complies with the following directives and their transpositions into national law* :

**2006/42/CE**

8) Pour les machines annexe IV, *For annex IV machines* :

9) Numéro d'attestation, *Certificate number* :

10) Organisme notifié, *Notified body* :

15) Normes harmonisées utilisées, *Harmonised standards used* :

16) Normes ou dispositions techniques utilisées, *Standards or technical provisions used* :

17) Fait à, *Done at* :

18) Date, *Date* :

19) Nom du signataire, *Name of signatory* :

20) Fonction, *Function* :

21) Signature, *Signature* :

**bg :** 1) удостоверение за « CE » съответствие (оригинална), 2) Фирмата, 3) Адрес, 4) Техническо досие, 5) Фабрикант на описаната по-долу машина, 6) Обявява, че тази машина, 7) Отговаря на следните директиви и на тяхното съответствие национално право, 8) За машините към допълнение IV, 9) Номер на удостоверението, 10) Наименована фирма, 15) хармонизиран стандарт използвани, 16) стандарти или технически правила, използвани, 17) Изработено в, 18) Дата, 19) Име на разписалия се, 20) Функция, 21) Функция.

**cs :** 1) ES prohlášení o shodě (původní), 2) Název společnosti, 3) Adresa, 4) Technická dokumentace, 5) Výrobce níže uvedeného stroje, 6) Prohlašuje, že tento stroj, 7) Je v souladu s následujícími směrnici a směrnici transponovanými do vnitrostátního práva, 8) Pro stroje v příloze IV, 9) Číslo certifikátu, 10) Notifikační orgán, 15) harmonizované normy použity, 16) Norem a technických pravidel používaných, 17) Místo vydání, 18) Datum vydání, 19) Jméno podepsaného, 20) Funkce, 21) Podpis.

**da :** 1) EF Overensstemmelseerklæring (original), 2) Firmaet, 3) Adresse, 4) tekniske dossier, 5) Konstruktor af nedenfor beskrevne maskine, 6) Erklærer, at denne maskine, 7) Overholder nedennævnte direktiver og disses gennemførelse til national ret, 8) For maskiner under bilag IV, 9) Certifikat nummer, 10) Bemyndigede organ, 15) harmoniserede standarder, der anvendes, 16) standarder eller tekniske regler, 17) Udfærdiget i, 18) Dato, 19) Underskrivers navn, 20) Funktion, 21) Underskrift.

**de :** 1) EG-Konformitätserklärung (original), 2) Die Firma, 3) Adresse, 4) Technischen Unterlagen, 5) Hersteller der nachfolgend beschriebenen Maschine, 6) Erklärt, dass diese Maschine, 7) den folgenden Richtlinien und deren Umsetzung in die nationale Gesetzgebung entspricht, 8) Für die Maschinen laut Anhang IV, 9) Bescheinigungsnummer, 10) Benannte Stelle, 15) angewandten harmonisierten Normen, 16) angewandten sonstigen technischen Normen und Spezifikationen, 17) Ausgestellt in, 18) Datum, 19) Name des Unterzeichners, 20) Funktion, 21) Unterschrift.

**el :** 1) Δήλωση συμμόρφωσης CE (πρωτότυπο), 2) Η εταιρεία, 3) Διεύθυνση, 4) τεχνικό φάκελο, 5) Κατασκευάστρια του εξής περιγραφόμενου μηχανήματος, 6) Δηλώνει ότι αυτό το μηχάνημα, 7) Είναι σύμφωνο με τις εξής οδηγίες και τις προσαρμογές τους στο εθνικό δίκαιο, 8) Για τα μηχανήματα παραρτήματος IV, 9) Αριθμός δήλωσης, 10) Κοινοποιημένος φορέας, 15) εναρμονισμένα πρότυπα που χρησιμοποιούνται, 16) Πρότυπα ή τεχνικούς κανόνες που χρησιμοποιούνται, 16) Είναι σύμφωνο με τα εξής πρότυπα και τεχνικές διατάξεις, 17) Ev, 18) Ημερομηνία, 19) Όνομα του υπογράφοντος, 20) Θέση, 21) Υπογραφή.

**es :** 1) Declaración DE de conformidad (original), 2) La sociedad, 3) Dirección, 4) expediente técnico, 5) Constructor de la máquina descrita a continuación, 6) Declara que esta máquina, 7) Está conforme a las siguientes directivas y a sus transposiciones en derecho nacional, 8) Para las máquinas anexo IV, 9) Número de certificación, 10) Organismo notificado, 15) normas armonizadas utilizadas, 16) Otras normas o especificaciones técnicas utilizadas, 17) Hecho en, 18) Fecha, 19) Nombre del signatario, 20) Función, 21) Firma.

**et :** 1) EÜ vastavusdeklaratsioon (algupärane), 2) Äriühing, 3) Aadress, 4) Tehniline dokumentatsioon, 5) Seadme tootja, 6) Kinnitab, et see toode, 7) On vastavuses järgmistele direktiivide ja nende riigisisesele õigussesse ülevõtmiseks vastuvõetud õigusaktidega, 8) IV lisas loetletud seadmete puhul, 9) Tunnistuse number, 10) Sertifitseerimisasutus, 15) kasutatud ühtlustatud standarditele, 16) Muud standardites või spetsifikatsioonides kasutatakse, 17) Väljaandmise koht, 18) Väljaandmise aeg, 19) Allkirjastaja nimi, 20) Amet, 21) Allkiri.

**fi :** 1) EY-vaatimustenmukaisuusvakuutus (alkuperäiset), 2) Yritys, 3) Osoite, 4) teknisen eritelmän, 5) Jäljessä kuvutun koneen valmistaja, 6) Vakuuttaa, että tämä kone, 7) Täyttää seuraavien direktiivien sekä niitä vastaavien kansallisten säännösten vaatimukset, 8) Liitteen IV koneiden osalta, 9) Todistuksen numero, 10) Ilmoitettu laitos, 15) yhdenmukaistettuja standardeja käytetään, 16) muita standardeja tai eritelmiä, 17) Paikka, 18) Aika, 19) Allekirjoittajan nimi, 20) Toimi, 21) Allekirjoitus.

**ga :** 1) « EC » dearbhú comhréireachta (bunaidh), 2) An comhlacht, 3) Seoladh, 4) comhad teicniúil, 5) Déantóir an innill a thuaireascáir thíos, 6) Dearbháinn sé go bhfuil an t-inneall, 7) Go gclóinn sé le na teoracha seo a leanas agus a trasúimh isteach i ndlí náisiúnta, 8) Le haghaidh innill an aghuisín IV, 9) Uimhir teastais, 10) Comhlacht a chuireadh i bhfios, 15) caighdeán comhchuíbhíthe a úsáidtear, 16) caighdeán eile nó sonraíochtaí teicniúla a úsáidtear, 17) Déanta ag, 18) Dáta, 19) Ainm an tsintheora, 20) Feidhm, 21) Síniú.

**hu :** 1) CE megfelelőési nyilatkozat (eredeti), 2) A vállalat, 3) Cím, 4) műszaki dokumentáció, 5) Az alábbi gép gyártója, 6) Kijelenti, hogy a gép, 7) Megfelel az alábbi irányelveknek valamint azok honosított előírásainak, 8) A IV. melléklet gépeihez, 9) Bizonylati szám, 10) Ertesített szervezet, 15) felhasznált harmonizált szabványok, 16) egyéb felhasznált műszaki szabványok és előírások hivatkozásai, 17) Kelt (hely), 18) Dátum, 19) Aláíró neve, 20) Funkció, 21) Aláírás.

**is :** 1) Samræmisvottorð ESB (upprunalega), 2) Fyrirtækið, 3) Aðsetur, 4) Tæknilegar skrá, 5) Smíður tækisins sem lýst er hér á eftir, 6) Staðfestir að tækið, 7) Samræmist eftirfarandi stöðlum og staðfærslu þeirra með hljóðjón af þjóðarrétti, 8) Fyrir tækin í aukakafa IV, 9) Staðfestingarnúmer, 10) Tilkynt til, 15) samhæfa staðla sem notaðir, 16) önnur staðlar eða forskrifir notað, 17) Staður, 18) Dagsetning, 19) Nafn undirritaðs, 20) Staða, 21) Undirskrift.

**it :** 1) Dichiarazione CE di conformità (originale), 2) La società, 3) Indirizzo, 4) fascicolo tecnico, 5) Costruttore della macchina descritta di seguito, 6) Dichiaro che questa macchina, 7) È conforme alle direttive seguite e alle relative trasposizioni nel diritto nazionale, 8) Per le macchine Allegato IV, 9) Numero di Attestazione, 10) Organismo notificato, 15) norme armonizzate applicate, 16) altre norme e specifiche tecniche applicate, 17) Stabilita a, 18) Data, 19) Nome del firmatario, 20) Funzione, 21) Firma.

**lt :** 1) CE atitikties deklaracija (originalas), 2) Bendrovė, 3) Adresas, 4) Techninė byla, 5) Žemiau nurodytas įrenginio gamintojas, 6) Pareiškia, kad šis įrenginys, 7) Atitinka toliau nurodytas direktyvas ir į nacionalinius teisės aktus perkeltas jų nuostatas, 8) IV priedas dėl mašinų, 9) Sertifikuoto Nr, 10) Paskelbtosios įstaiga, 15) suderintus standartus naudojamus, 16) Kiti standartai ir techninės specifikacijos, 17) Pasirašyta, 18) Data, 19) Pasirašiusio asmens vardas ir pavardė, 20) Pareigos, 21) Parašas.

**lv :** 1) EK atbilstības deklarācija (oriģināls), 2) Uzņēmums, 3) Adrese, 4) tehniskās lietas, 5) Tālāk aprakstītās iekārtas ražotājs, 6) Apliecina, ka šīs iekārtas, 7) Ir atbilstošas tālāk norādītajām direktīvam un to transpozīcijai nacionālajā likumdošanā, 8) Iekārtām IV pielikumā, 9) Apliecināšanas numurs, 10) Reģistrētā organizācija, 15) lietotajiem saskaņotajiem standartiem, 16) lietotajiem tehniskajiem standartiem un specifikācijām, 17) Sastādīts, 18) Datums, 19) Parakstītāja vārds, 20) Amats, 21) Paraksts.

**mt :** 1) Dikjarazzjoni ta' Konformità KE (oriġinali), 2) Il-kompanija, 3) Indirizz, 4) fajl tekniku, 5) Manifattriċi tal-magna deskritta hawn isfel, 6) Tiddikjara li din il-magna, 7) Hija konformi hija konformi mad-Direttivi segwenti u l-Higijiet li jimplimentawhom fil-ligji nazzjonali, 8) Għall-magni fl-Anness IV, 9) Numru taċ-certifikat, 10) Entità nnotifikata, 15) l-Istandards armonizzati użati, 16) standards tekniċi u specifikazzjonijiet oħra użati, 17) Magħmul f', 18) Data, 19) Isem il-firmatarju, 20) Kariga, 21) Firma.

**nl :** 1) EG-verklaring van overeenstemming (oorspronkelijke), 2) Het bedrijf, 3) Adres, 4) technisch dossier, 5) Constructeur van de hierna genoemde machine, 6) Verklaart dat deze machine, 7) In overeenstemming is met de volgende richtlijnen en hun omzettingen in het nationale recht, 8) Voor machines van bijlage IV, 9) Goedkeuringsnummer, 10) Aangezegde instelling, 15) gehanteerde geharmoniseerde normen, 16) andere gehanteerde technische normen en specificaties, 17) Opgemaakt te, 18) Datum, 19) Naam van ondergetekende, 20) Functie, 21) Handtekening.

**no :** 1) CE-samsvarserklæring (original), 2) Selskapet, 3) Adresse, 4) tekniske arkiv, 5) Fabrikant av følgende maskin, 6) Erklærer at denne maskinen, 7) Oppfyller kravene i følgende direktiver, med nasjonale gjennomføringsbestemmelser, 8) For maskinene i tillegg IV, 9) Attestnummer, 10) Notifisert organ, 15) harmoniserte standarder som brukes, 16) Andre standarder og spesifikasjoner brukt, 17) Utstedt i, 18) Dato, 19) Underskriverens navn, 20) Stilling, 21) Underskrift.

**pl :** 1) Deklaracja zgodności CE (oryginalne), 2) Spółka, 3) Adres, 4) dokumentacji technicznej, 5) Wykonawca maszyny opisanej poniżej, 6) Oświadcza, że ta maszyna, 7) Jest zgodna z następującymi dyrektywami i odpowiadającymi przepisami prawa krajowego, 8) Dla maszyn załącznik IV, 9) Numer certyfikatu, 10) Jednostka certyfikująca, 15) zastosowanych norm zharmonizowanych, 16) innych zastosowanych norm technicznych i specyfikacji, 17) Sporządzono w, 18) Data, 19) Nazwisko podpisującego, 20) Stanowisko, 21) Podpis.

**pt :** 1) Declaração de conformidade CE (original), 2) A empresa, 3) Morada, 4) processo técnico, 5) Fabricante da máquina descrita abaixo, 6) Declara que esta máquina, 7) Está em conformidade às directivas seguintes e às suas transposições para o direito nacional, 8) Para as máquinas no anexo IV, 9) Número de certificado, 10) Entidade notificada, 15) normas harmonizadas utilizadas, 16) outras normas e especificações técnicas utilizadas, 17) Elaborado em, 18) Data, 19) Nome do signatário, 20) Cargo, 21) Assinatura.

**ro :** 1) Declarație de conformitate CE (originală), 2) Societatea, 3) Adresa, 4) cărții tehnice, 5) Constructor al mașinii descrise mai jos, 6) Declară că prezenta mașină, 7) Este conformă cu directivele următoare și cu transpunerea lor în dreptul național, 8) Pentru mașinile din anexa IV, 9) Număr de atestare, 10) Organism notificat, 15) standardele armonizate utilizate, 16) alte standarde și specificații tehnice utilizate, 17) Intocmit la, 18) Data, 19) Numele persoanei care semnează, 20) Funcția, 21) Semnătura.

**sk :** 1) ES vyhlásenie o zhode (pôvodný), 2) Názov spoločnosti, 3) Adresa, 4) technickej dokumentácie, 5) Výrobca nižšie opísaného stroja, 6) Vyhlasuje, že tento stroj, 7) Je v súlade s nasledujúcimi smernicami a smernicami transponovanými do vnútroštátneho práva, 8) Pre stroje v prílohe IV, 9) Číslo certifikátu, 10) Notifikačný orgán, 15) použité harmonizované normy, 16) použité iné technické normy a predpisy, 17) Miesto vydania, 18) Dátum vydania, 19) Meno podpisujúceho, 20) Funkcia, 21) Podpis.

**sl :** 1) ES Izjava o ustreznosti (izvirna), 2) Družba, 3) Naslov, 4) tehnične dokumentacije, 5) Proizvajalac tukaj opisanega stroja, 6) Izjavlja, da je ta stroj, 7) Ustreza naslednjim direktivam in njihovi transpoziciji v državno pravo, 8) Za stroje priloga IV, 9) Številka potrdila, 10) Obvestilo organu, 15) uporabljene harmonizirane standarde, 16) druge uporabljene tehnične standarde in zahteve, 17) V, 18) Datum, 19) Ime podpisnika, 20) Funkcija, 21) Podpis.

**sv :** 1) CE-försäkran om överensstämmelse (original), 2) Företaget, 3) Adress, 4) tekniska dokumentationen, 5) Konstruktor av nedan beskrivna maskin, 6) Försäkrat att denna maskin, 7) Överensstämmer med nedanstående direktiv och införlivandet av dem i nationell rätt, 8) För maskinerna i bilaga IV, 9) Nummer för godkännande, 10) Organism som underrättats, 15) Harmoniserade standarder som använts, 16) andra tekniska standarder och specifikationer som använts, 17) Upprättat i, 18) Datum, 19) Namn på den som undertecknat, 20) Befattning, 21) Namnteckning.

## SAFETY PLATES AND STICKERS

### ⚠ IMPORTANT ⚠

Clean all of the stickers and safety plates to make them legible.  
It is essential to replace stickers and safety plates which are illegible or damaged.  
Check the presence of stickers and safety plates after replacing any spare parts.

### EXTERNAL PLATES AND STICKERS

ITEM	PART No.	DESCRIPTION
1	234805	- Hydraulic coupling instruction
2	296998	- Maniscopic safety instruction
3	24653	- Slingsing point
4	289101	- Tie-down point
5	234798	- Hydraulic oil
6	288430	- Repairing instructions (on lift cylinder)
7	268491	- Break fluid instruction
8	305405	- Diesel fuel
9	289013	- Towing instruction (option)
10	307508	- Battery cut-off instruction

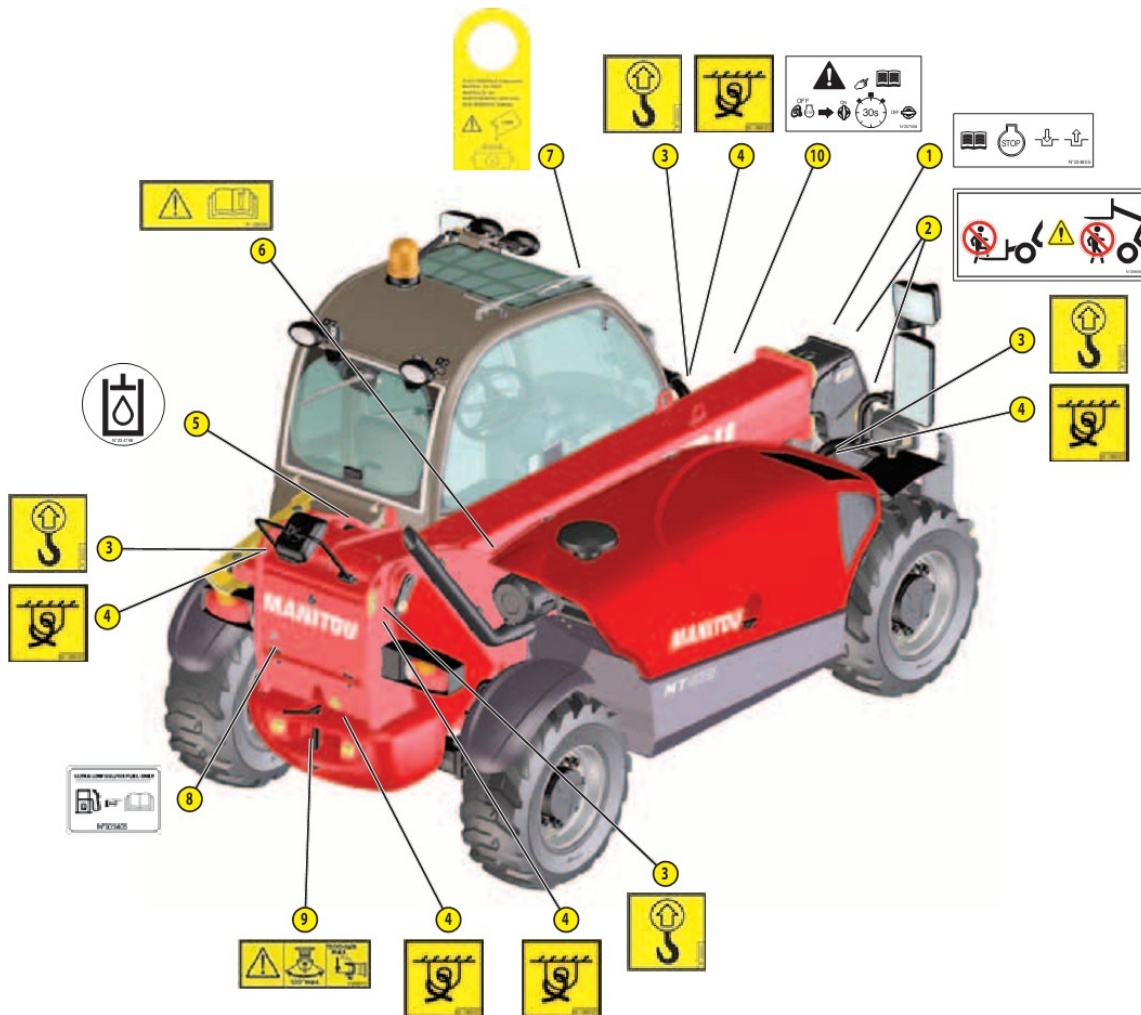



**PLATES AND STICKERS IN THE CAB**

ITEM	PART No.	DESCRIPTION
1	240805	- Reach chart sheet
2	52509004	- Manipulator function sheet
3	241621	- Safety instruction sheet
4	Consult your dealer	- Load chart
5	52515060	- Fuse sheet
6	52509862	- Relay sheet
7	294831	- Screen display function sheet
8	288638	- Lifting ring on carriage sheet (option)
10	290183	- Bucket instruction on telescope
11	297733	- Operating mode management instruction
12	52515381	- Main functions
13	265284	- Lifting ring on carriage (option)
14	184276	- Steering selection
15	172385	- Towing forbidden
16	239594	- Sound power level
17	193032	- Cab compliance
18	Consult your dealer	- Manufacturer's plate
19	52527267	- Consumption sheet



## IDENTIFICATION OF THE LIFT TRUCK

As our policy is to promote a constant improvement of our products, our range of telescopic lift trucks may undergo certain modifications, without obligation for us to advise our customers.

When you order parts, or when you require any technical information, always specify:

NOTE: For the owner's convenience, it is recommended that a note of these numbers is made in the spaces provided, at the time of the delivery of the lift truck.

### LIFT TRUCK MANUFACTURER'S PLATE

- 1 - MODEL
- 2 - SERIES
- 3 - Year of manufacture
- 4 - Model year
- 5 - Serial No.
- 6 - Power ISO 3046
- 7 - Empty ground
- 8 - Authorized gross vehicle weight
- 9 - Rated capacity
- 10 - Pulling force
- 11 - Maximum vertical force (on trailer hook)
- 12 - Tire pressure (bar)
- 13 - Homologation No.

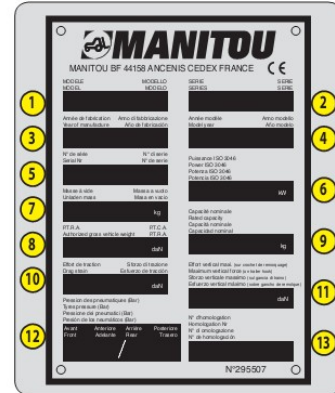

For any further technical information regarding your lift truck refer to chapter: 2 - DESCRIPTION: CHARACTERISTICS.

### ENGINE

- Model
- Serial No.
- Engine No.

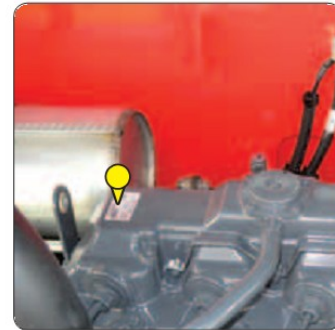

### HYDROSTATIC PUMP

- MANITOU reference
- Type of codification
- Serial No.
- Manufacturer's No.
- Year of manufacture



### HYDROSTATIC MOTOR

- MANITOU reference
- Type of codification
- Serial No.
- Manufacturer's No.
- Year of manufacture

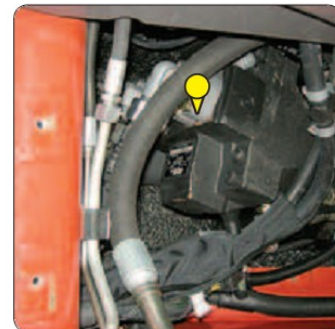

647511 (09/09/2016)  
MT 625 H EASY 49 K33A S1

### FRONT AXLE

- Type
- Serial No.
- MANITOU reference

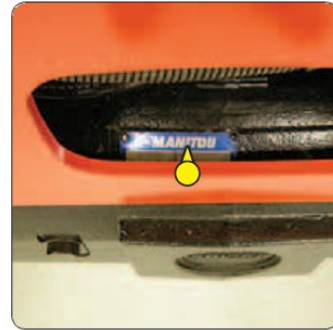

### REAR AXLE

- Type
- Serial No.
- MANITOU reference

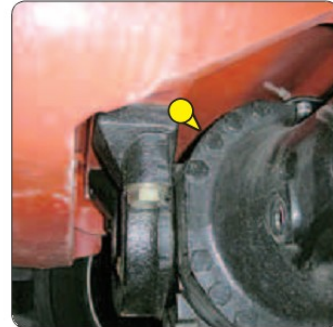

### CAB

- Type
- Serial No.



### JIB

- MANITOU reference
- Date of manufacture



### CHASSIS

- Lift truck serial No.



### CONNECTION MANUFACTURER'S PLATE

- Model
- Serial No.
- Year of manufacture

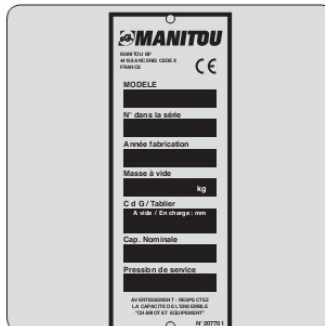



## CHARACTERISTICS

ENGINE		
Type		KUBOTA V2607-DI-E3B-MNT
Fuel		Diesel
Number of cylinders		4 in line
Suction		Supercharged
Injection system		Direct
Ignition sequence		1.3.4.2
Capacity	cm <sup>3</sup>	2615
Bore and stroke	mm	87 x 110
Compression ratio		20
Nominal speed laden	rpm	2700
Min. rpm unladen	rpm	875
Max. rpm unladen	rpm	2870
Power ISO 3046-1	hp - kW	49 - 36
Power SAE J 1995	hp - kW	49 - 36
Maximum torque ISO 3046-1	Nm	170 at 1600 rpm
Air cleaner	µm	3
Type of cooling		By water
Fan		Puller

TRANSMISSION		
Hydrostatic pump		DANFOSS
- Type		Variable displacement piston motor
- Forward/reverse selector		Electro-hydraulic
- Number of forward gears		2 (1 slow and 1 fast)
- Number of reverse gears		2 (1 slow and 1 fast)
Main pump		
- MAX./MIN. displacement	cm <sup>3</sup> /rev	0 - 53
- MAX. flow rate	l/mn	143
- Working pressure	bar	350
Booster pump		
- Capacity	cm <sup>3</sup> /rev	12
- MAX. flow rate	l/mn	31
- Boost pressure MAX. rpm	bar	24 (transmission in neutral)
Hydrostatic motor		DANFOSS
- Type		Variable displacement piston motor
- MAX./MIN. displacement	cm <sup>3</sup> /rev	29 - 110
Transfer gear box		DANA
Front axle		DANA
- Differential		45 % limited slip differential
Rear axle		DANA
- Differential		Without locking
Drive wheels		Permanent 4 WD
- 2/4 wheel drive control		No
Front tires		SOLIDEAL
- Size		12-16,5 12PR SKS XT TUBELESS
- Pressure	bar	5,6
Rear tires		SOLIDEAL
- Size		12-16,5 12PR SKS XT TUBELESS
- Pressure	bar	5,6

ELECTRIC CIRCUIT		
Battery	Standard	12V - 110 Ah - 750 A EN
	Option	12V - 110 Ah - 900 A EN
Alternator		12V - 80 A
- Type		A5TA59 77C
Starter		12V - 3 kW
- Type		M008T50672

SOUND AND VIBRATION		
Sound pressure level in the driver's cab LpA (according to standard NF EN 12053)	dB(A)	76 (cab closed)
Sound pressure (according to directive 2009/76)	dB(A)	(cab closed); (cab open)
Sound pressure level ensured in the LwA environment (according to directive 2000/14/EC modified by directive 2005/88/EC)	dB(A)	104 (measured); 104 (guaranteed)
Sound level in motion (according to directive 2009/63)	dB(A)	
Average weighted acceleration on driver's body (according to standard NF EN 13059)	m/s <sup>2</sup>	
The average weighted acceleration transmitted to the driver's hand/ arm system (according to ISO 5349-2)	m/s <sup>2</sup>	< 2,5
Standard seat vibration	m/s <sup>2</sup>	(lightweight operator); (heavyweight operator)

647511 (09/09/2016)  
MT 625 H E6SY 49 K33A 51

<b>BRAKE CIRCUIT</b>	
Service brake	Non-servo hydraulic brake
- Type of brake	Oil-immersed multi-disc brake
- Type of control	By foot on front axle
Parking brake	Low pressure hydraulic brake
- Type of brake	Oil-immersed multi-disc brake
- Type of control	Switch-operated electro-hydraulic

<b>HYDRAULIC CIRCUIT</b>	
Hydraulic pump	
- Type	Double gear pump
	1st casing
- Capacity	cm <sup>3</sup>
- Max. rating capacity unladen	28
- Flow rate at 1600 rpm	l/mn
	80,4
	44,8
Filtration	
- Return	µm
- Suction	µm
	10
	125
Maximum service pressure	bar
	235
- Telescoping circuit	bar
	235 / 235
- Lifting circuit	bar
	235 / 235
- Tilting circuit	bar
	245 / 245
- Attachment circuit	bar
	235
- Steering circuit	bar
	140

<b>HYDRAULIC MOVEMENTS</b>	
Longitudinal stability limiter and warning device	Electronic
Lifting motions (boom retracted)	
- Unladen lifting	s - m/mn
	8,9 - 25,4
- Laden lifting	s - m/mn
	9,1 - 24,9
- Unladen lowering	s - m/mn
	6 - 37,7
- Laden lowering	s - m/mn
	6,2 - 36,5
Telescoping motions (boom raised)	
- Unladen extending	s - m/mn
	6,1 - 21,2
- Laden extending	s - m/mn
	6,2 - 21,5
- Unladen retracting	s - m/mn
	3,9 - 33,7
- Laden retracting	s - m/mn
	3,7 - 35,5
Tilting movements	
- Unladen digging	s - °/s
	3 - 42,8
- Forward tilting unladen	s - °/s
	3,3 - 38,9

<b>SPECIFICATIONS AND WEIGHTS</b>	
Speed of movement for lift truck in standard configuration on flat ground	
• Front unladen 1 slow	km/h
	7,0
• 1 fast	km/h
	24,7
• Rear unladen 1 slow	km/h
	7,0
• 1 fast	km/h
	24,7
Standard attachment	PFB 25 N MT 1020
- Weight of attachment (without forks)	kg
	80
- Weight of forks (each)	kg
	72,5
Rated capacity with standard attachment	kg
	2500
Tipping load at maximum reach on tires	kg
	500
Distance from the center of gravity of the load to the heel of the forks	mm
	5820
Standard lifting height	mm
	4485
Weight of lift truck without attachment	kg
	4710
Weight of lift truck with standard attachment	kg
- Unladen	kg
	7210
- At rated load	kg
	2260
Weight per axle with standard attachment (transport position)	kg
- Front unladen	kg
	2450
- Rear unladen	kg
	6600
- Front rated load	kg
	610
- Rear rated load	kg
	5170
Weight per axle with standard attachment (boom extended)	kg
- Front rated load	kg
	340
- Rear rated load	kg
	3080
Drag strain on the coupling hook	daN
- Unladen (sliding)	daN
	3450
- At rated load (transmission setting)	daN
	3427
Breakout force with bucket (according to ISO 8313)	daN

647511 (09/09/2016)  
MT 625 H EGSY 49 KSTR A 5T

## TIRES

		PRESSURE (bar)	TYRE LOAD (kg)			
			FRONT UNLADEN	FRONT LADEN	REAR UNLADEN	REAR LADEN
SOLIDEAL	12-16,5 12PR SKS CL TUBELESS	5,6	1100	3250	1250	350
	12-16,5 12PR SKS HF-3 TUBELESS	5,6				
	12-16,5 10PR SKS R1	3,4				
HAULER	12-16,5 12PR SKS TUBELESS	5,6				
MICHELIN	305/70 R16,5 141A5 TL	4,8				

		PRESSURE (bar)	LOAD (kg)	PRESSURE ON THE CONTACT SURFACE (kg/cm <sup>2</sup> )		AREA OF THE CONTACT SURFACE (cm <sup>2</sup> )	
				HARD SOIL	LOOSE SOIL	HARD SOIL	LOOSE SOIL
				SOLIDEAL	12-16,5 12PR SKS CL TUBELESS	5,6	350
			1100	7,97	4,00	138	275
			1250	8,01	4,01	156	312
			3250	10,00	5,00	325	650
SOLIDEAL	12-16,5 12PR SKS HF-3 TUBELESS	5,6	350	8,54	2,99	41	117
			1100	11,00	3,50	100	314
			1250	10,96	3,50	114	357
			3250	13,54	4,72	240	689
SOLIDEAL	12-16,5 12PR SKS R1 TUBELESS	3,4	350				
			1100				
			1250				
			3250				
HAULER	12-16,5 12PR SKS TUBELESS	5,6	350	5,00	2,50	70	140
			1100	7,01	3,50	157	314
			1250	7,02	3,50	178	357
			3250	11,02	5,51	295	590
MICHELIN	305/70 R16,5 141A5 TL BIBSTEEL ALL TERRAIN	4,8	350				
			1100				
			1250				
			3250				

## DIMENSIONS AND LOAD CHART

A	mm	1200
B	mm	2300
C	mm	991
C1	mm	928
D	mm	3894
D1	mm	3831
D2	mm	3275
E	mm	5094
F	mm	1492
F1	mm	1492
G	mm	240
G1	mm	330
G2	mm	253
G3	mm	-
H	°	-
H1	°	-
I	mm	603
J	mm	797
K	mm	1015
L	mm	45
N	mm	1314
O	mm	125
P2	°	37
P3	°	52
R	mm	3150
S	mm	6651,5
T	mm	3935
U1	mm	1920
U2	mm	2054
V	mm	4700
V1	mm	765
V2	mm	3310,5
W	mm	1813
W1	mm	-
W2	mm	-
W3	mm	-
Y	°	12
Z	°	117

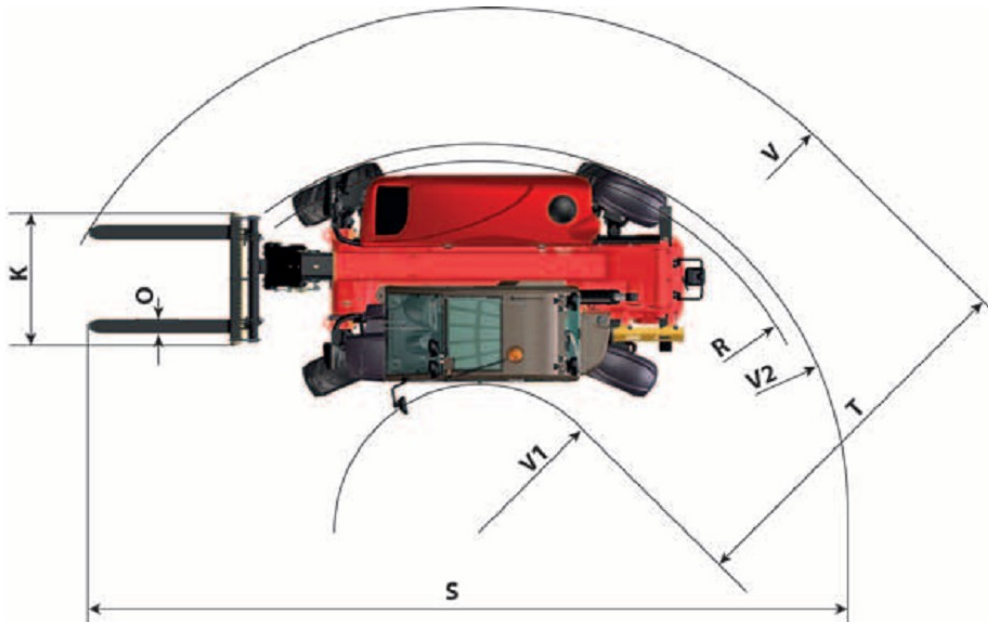
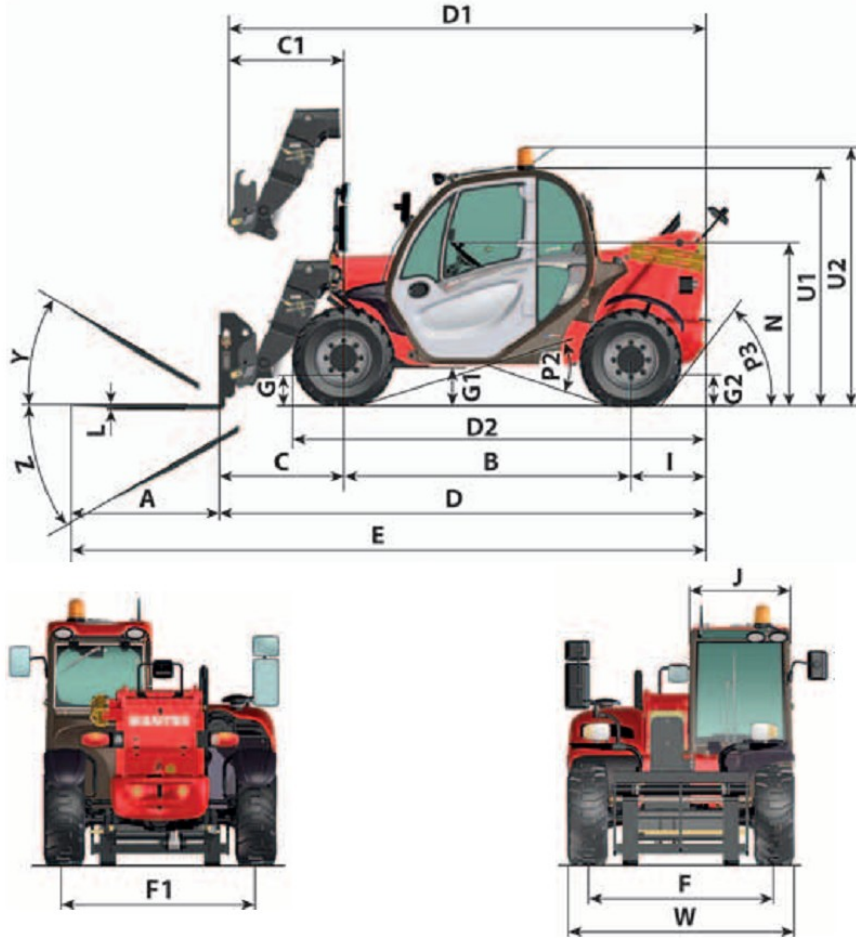

647511 (09/09/2016)  
MT 625 H E6SY 49 K53A S1

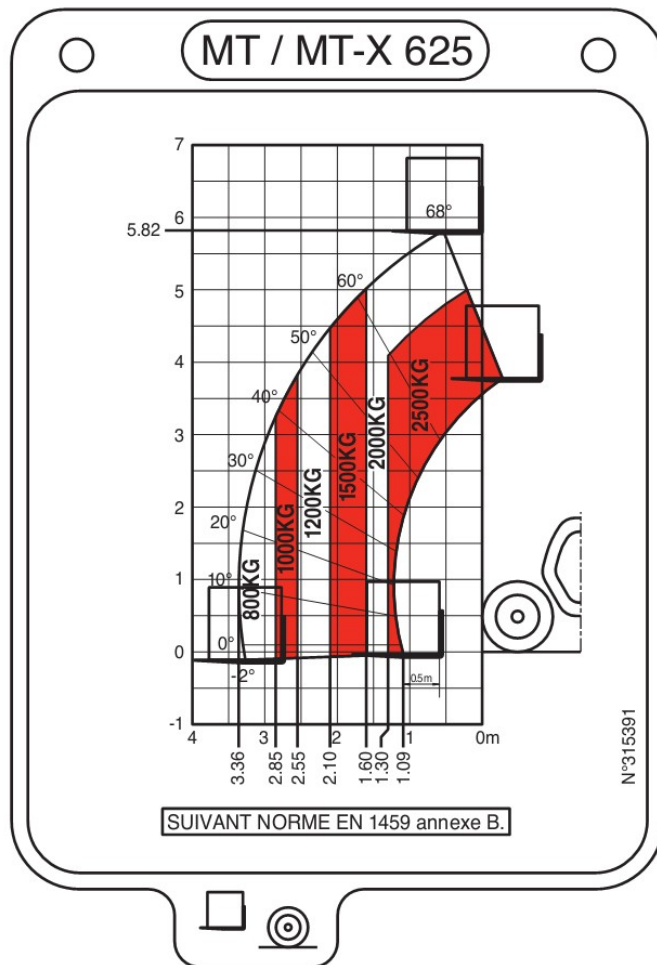

## VISIBILITY

Our lift trucks conform to European standard EN15830 with regard to operator visibility.

- Follow the instructions for optimizing operator visibility of the immediate vicinity (see: 1 - OPERATING AND SAFETY INSTRUCTIONS: INSTRUCTIONS TO THE OPERATOR: DRIVING INSTRUCTIONS UNLADEN AND LADEN: D - VISIBILITY).

### DESCRIPTION AND ADJUSTMENT OF REAR-VIEW MIRRORS

- 1 - LEFT REAR-VIEW MIRROR
- 2 - MAIN RIGHT REAR-VIEW MIRROR
- 3 - CENTRAL RIGHT REAR-VIEW MIRROR
- 4 - UPPER RIGHT REAR-VIEW MIRROR
- 5 - REAR REAR-VIEW MIRROR

- Place the lift truck on level ground with the engine stopped, and the boom retracted and lowered as far as possible.
- Note the position of the reference points ●○○ in the illustrations, to see and correctly adjust the rear-view mirrors.

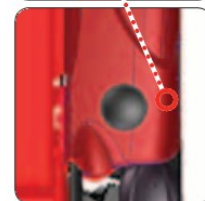
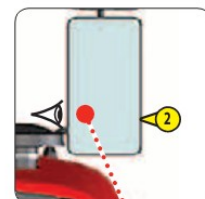
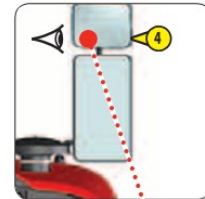
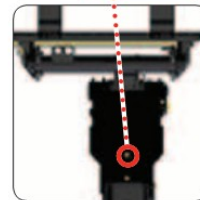
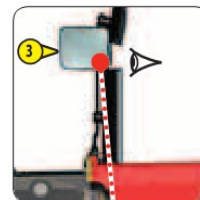
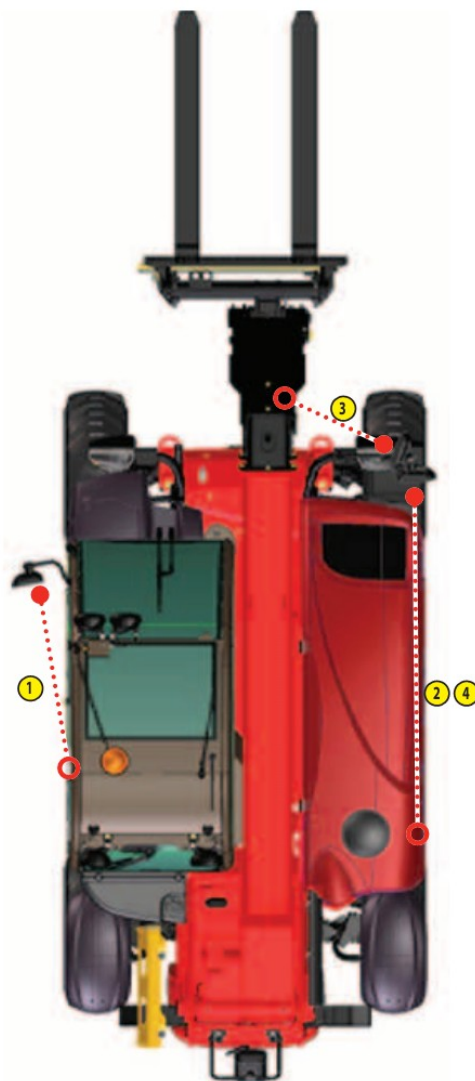
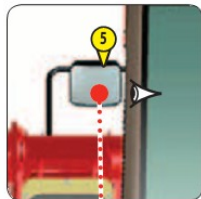
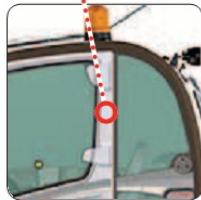
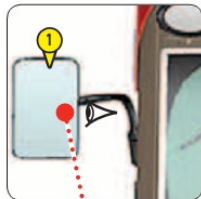

647511 (09/09/2016)  
MT 625 H E6SY 49 K53A S1

**DIRECT AND/OR INDIRECT VISIBILITY BLIND SPOT ZONES**

In accordance with EN15830, the two diagrams indicate blind spot zones on the visibility test circle (r 12m) and the 1 m rectangular zone around the lift truck.

**HANDLING SUSPENDED LOADS**

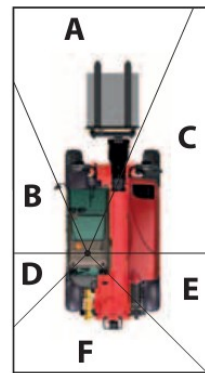
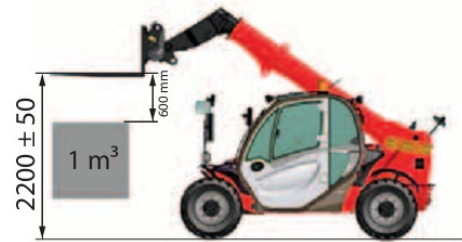
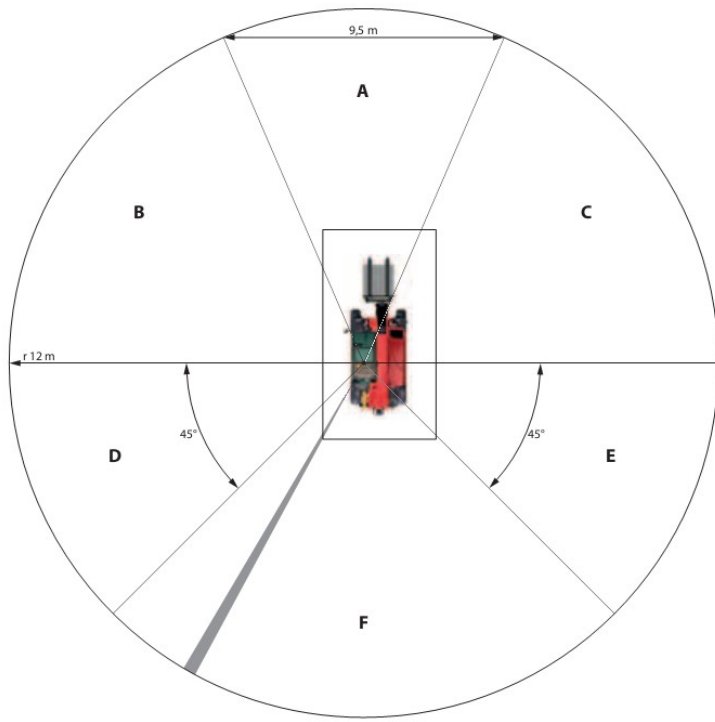

**LOADING THE TRAILER**

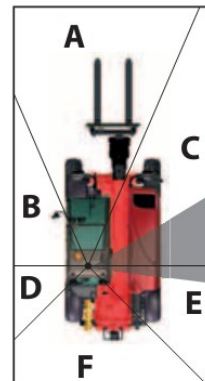
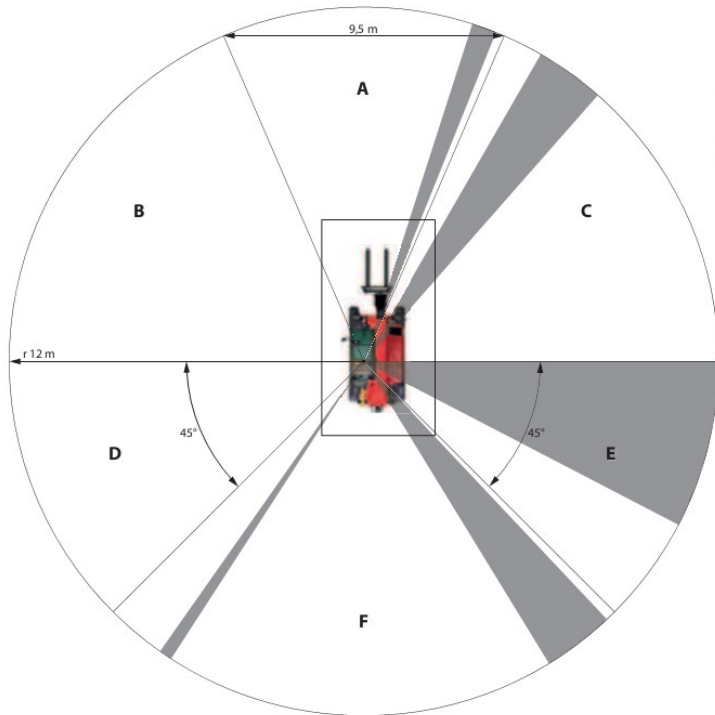

647511 (09/09/2016)  
MT 625 H E6SY 49 K3BA S1

# INSTRUMENTS AND CONTROLS

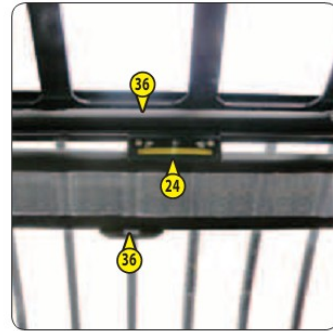
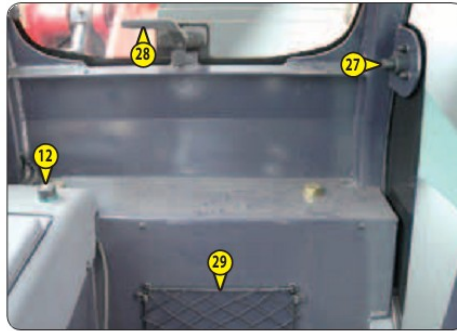
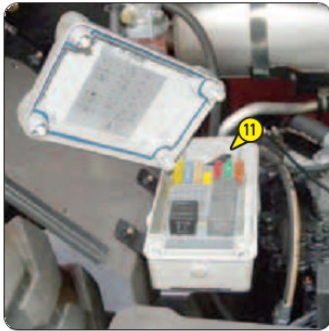
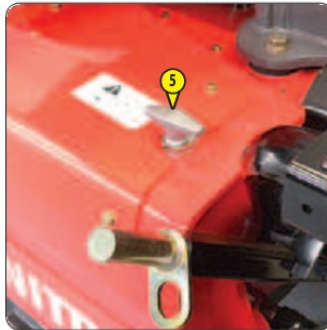



## DESCRIPTION

---

- 1 - DRIVER'S SEAT
- 2 - SEAT BELT
- 3 - IGNITION SWITCH
- 4 - EMERGENCY STOP BUTTON
- 5 - BATTERY CUT-OFF
- 6 - MAN-MACHINE INTERFACE (MMI)
- 7 - LONGITUDINAL STABILITY LIMITER AND WARNING DEVICE
- 8 - SWITCHES
- 9 - ARMREST AND STORAGE
- 10 - FUSES AND RELAYS IN THE CAB
- 11 - FUSES AND RELAYS UNDER THE ENGINE BONNET
- 12 - CIGARETTE LIGHTER
- 13 - LIGHTING, HORN AND INDICATOR LIGHT SWITCH
- 14 - FRONT AND REAR WINDSCREEN WIPER SWITCH
- 15 - FUNCTION FILES
- 16 - HYDRAULIC CONTROLS
- 17 - ACCELERATOR PEDAL
- 18 - SERVICE BRAKE PEDAL AND TRANSMISSION CUT-OFF
- 19 - FORWARD/NEUTRAL/REVERSE GEAR SELECTION
- 20 - STEERING SELECTION
- 21 - HEATER CONTROL
- 22 - HEATING VENTS
- 23 - WINDSCREEN DEMISTER VENTS
- 24 - LEVEL INDICATOR
- 25 - DOOR LOCK
- 26 - DOOR WINDOW OPENING HANDLE
- 27 - DOOR WINDOW RELEASE BUTTON
- 28 - HANDLE FOR REAR WINDOW OPENING
- 29 - DOCUMENT HOLDER NET
- 30 - STEERING WHEEL ADJUSTMENT LEVER
- 31 - FRONT HEADLIGHTS (NOT ILLUSTRATED)
- 32 - REAR LIGHTS (NOT ILLUSTRATED)
- 33 - ROTATING BEACON LIGHT (OPTION)
- 34 - CEILING LIGHT (OPTION) (NOT ILLUSTRATED)
- 35 - ROOF WINDSCREEN WIPER SWITCH (OPTION) (NOT ILLUSTRATED)
- 36 - SUN VISOR (OPTION)
- 37 - DIAGNOSTIC PLUG
- 38 - BOOM SAFETY WEDGE

NOTE: All the terms such as: RIGHT, LEFT, FRONT, REAR are as seen by an observer seated on driver's seat and looking straight ahead.

## 1 - DRIVER'S SEAT

### DRIVER'S SEAT (STANDARD)

DESIGNED FOR MAXIMUM COMFORT, THIS SEAT CAN BE ADJUSTED AS FOLLOWS.

#### WEIGHT ADJUSTMENT

Adjust the weight when the driver is sitting on the seat.

- Pull the weight adjustment lever 1 fully out.
- Move the weight adjustment lever 1 up to increase the weight or down to reduce it.
- There are ten possible positions between the min and max weights. Before each run, return the lever to the central position. The max. or min. position is indicated by a freely traveling lever.
- The driver's weight is correctly adjusted when the arrow is in the center of indicator 2.
- After completing weight adjustment, fully lower the lever 1.

NOTE: To avoid any health problems, it is recommended that the weight should be checked and adjusted before starting up the lift truck.

#### LONGITUDINAL ADJUSTMENT

- Adjust the locking lever until you reach the position required. This then locks and the seat will not shift into another position.



*Only operate the lever by its recessed section and do not grasp from below, at the risk of crushing the hand.*

#### LUMBAR ADJUSTMENT

This increases the comfort of the seat and the driver's freedom of movement.

- Turn knob to 1 to adjust the height and depth of the lumbar support of the upper part of the back-rest.
- Turn knob to 2 to adjust the height and depth of the lumbar support of the lower part of the back-rest.

#### BACK-REST ANGLE ADJUSTMENT

- Support the back-rest, pull the lever and position the back-rest to find the desired position.



*If you do not support the back-rest when making adjustments, it will swing forwards.*

#### MAINTENANCE

Dirt may adversely affect the correct functioning of the seat. For this reason, make sure your seat is always clean.

- The cushions do not require to be removed from the seat frame for cleaning.



*A rocking back-rest increases the risk of an accident!*

First check the resistance of the fabric on a small concealed area before using any fabric and plastic cleaner.

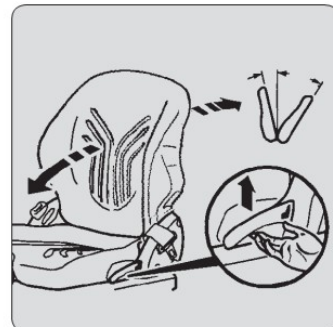
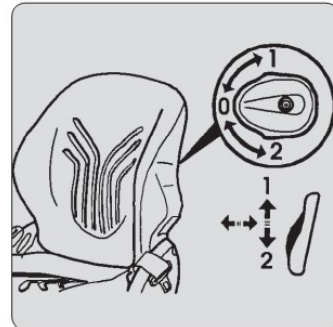
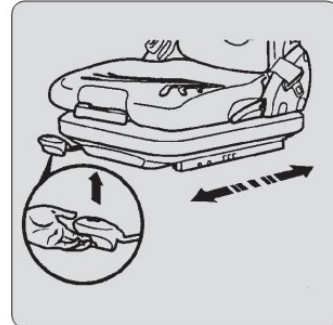
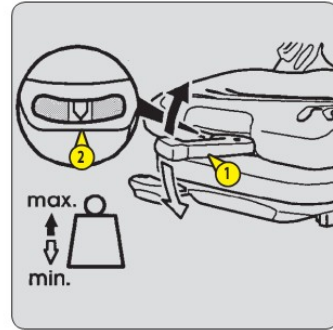

## 2 - SEAT BELT

### **⚠ IMPORTANT ⚠**

*In no event should the lift truck be used if the seat belt is defective (fixing, locking, cuts, tears, etc.).  
Repair or replace the seat belt immediately.*

- Sit correctly on the seat.
- Check that seat belt is not twisted.
- Place the seat belt at hip level.
- Attach the seat belt and check that it locks.
- Adjust the seat belt to your body shape without squeezing your hip and without over-slack.

## 3 - IGNITION SWITCH

The ignition switch has five positions:

- P - Not used.
- O - Ignition switched off and engine stopped.
- I - Ignition + preheat.
- II - Not used.
- III - The engine starts and returns to position I as soon as the key is released.

## 4 - EMERGENCY STOP BUTTON

In the event of danger, it enables the engine to be shut down, thereby cutting-off all hydraulic movements.

### **⚠ IMPORTANT ⚠**

*Warning, hydraulic movements suddenly stop when using this button.  
If possible, stop the lift truck before using the emergency stop button.*

- Turn the knob to deactivate it before restarting the lift truck.



## 5 - BATTERY CUT-OFF

For quickly disconnecting the battery when working on the electric circuit or when soldering, for example.

### **⚠ IMPORTANT ⚠**

*Operate the battery cut-off no less than 30 seconds after having switched off the ignition with the ignition key.*

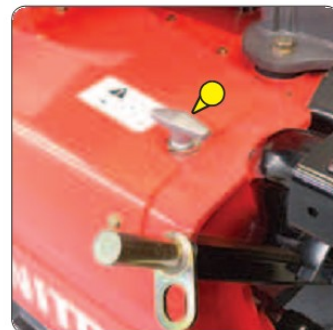

## 6 - MAN-MACHINE INTERFACE (MMI)

- 6A - CONTROL PANEL
- 6B - SCREEN DISPLAY

### 6A - CONTROL PANEL

#### ⚠ IMPORTANT ⚠

*A permanently lit or flashing warning lamp, with the engine running, is the sign of an operating fault. The lighting of some lamps may be accompanied by an audible signal. Do not ignore this warning, consult your dealer without delay. If one of the warning lamps comes on while the lift truck is in motion, stop the lift truck under the safest possible conditions.*



#### REV COUNTER

10 level LED display from 0 to 3000 rpm.



#### ENGINE WATER TEMPERATURE

Temperature zones:

- 1 LED - (< 40 °C) zone. Use the lift truck with moderation, wait for temperature to increase before normal operation.
- 2 LEDs - (40 °C - 60 °C) zone.
- 3 LEDs - (60 °C - 80 °C) zone.
- 4 LEDs - (80 °C - 85 °C) zone.
- 5 LEDs - (85 °C - 90 °C) zone.
- 6 LEDs - (90 °C - 95 °C) zone from 40 °C to 95 °C use the lift truck normally.
- 7 LEDs - (95 °C - 105 °C) zone. Use the lift truck with moderation.
- 8 LEDs - (105 °C - 110 °C) zone. Use the lift truck with moderation, ventilation control operating at full speed.
- 9 LEDs - Red zone (110 °C - 115 °C).
- 10 LEDs - Red zone (> 115 °C) Stop the lift truck, seek the cause of overheating.

NOTE: If the red indicator lamp  and the buzzer come on (> 110 °C) when the lift truck is running, stop the engine immediately and seek the cause of the failure in the cooling system.



#### FUEL LEVEL

When only one LED remains displayed, the orange indicator lamp  comes on, indicating that you are using the reserve fuel supply and that your operating time is limited.



#### FORWARD/NEUTRAL/REVERSE INDICATOR

See: 2 - DESCRIPTION: 19 - FORWARD/NEUTRAL/REVERSE GEAR SELECTION.



#### ORANGE AIR FILTER CLOGGING INDICATOR LAMP

The lamp and buzzer come on when the air filter cartridge is clogged up. When this lamp comes on, the cartridge needs changing. Stop the lift truck and carry out the necessary repairs (see cleaning and replacement intervals in chapter: 3 - MAINTENANCE: SERVICING SCHEDULE).



#### ORANGE HYDRAULIC OIL FILTER CLOGGING WARNING INDICATOR LAMP

The lamp and buzzer come on when the air filter cartridge or the hydraulic return oil filter cartridge is clogged up. Stop the lift truck and carry out the necessary repairs (see cleaning and replacement requirements in chapter: 3 - MAINTENANCE: FILTERS CARTRIDGES AND BELTS).



#### RED GENERAL FAULT WARNING INDICATOR LAMP

If the lamp and the buzzer come on when the lift truck is running, stop the engine immediately and consult your dealer.





**ORANGE TRANSMISSION OIL TEMPERATURE WARNING INDICATOR LAMP**

The lamp and the buzzer come on when the transmission oil temperature is abnormally high. Stop the lift truck and seek the cause of this overheating.



**ORANGE ENGINE WARNING INDICATOR LAMP**

If the indicator lamp comes on or flashes while the lift truck is in operation, a diagnostic fault has been detected. The lift truck will operate in reduced mode. Consult your dealer without delay.



**ORANGE FUEL LEVEL INDICATOR LAMP (see:  FUEL LEVEL)**



**RED BATTERY CHARGE INDICATOR LAMP**

If the lamp and the buzzer come on when the lift truck is running, stop the engine immediately and seek the cause (electric circuit, alternator belt, alternator, etc.).



**NO USED**



**NO USED**



**NO USED**



**NO USED**



**RED ENGINE OIL PRESSURE WARNING INDICATOR LAMP**

If the lamp and the buzzer come on when the lift truck is running, stop the engine immediately and seek the cause (see oil level in engine crankcase).



**RED ENGINE WATER TEMPERATURE INDICATOR LAMP (see:  ENGINE WATER TEMPERATURE)**

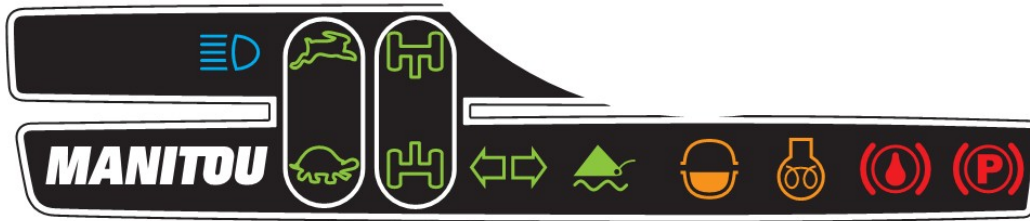

 **RED PARKING BRAKE INDICATOR LAMP**

This lamp comes on when the parking brake is applied (see: 2 - DESCRIPTION: 8 - SWITCHES).

 **RED BRAKE FLUID LEVEL INDICATOR LAMP**

If the lamp comes on, when the lift truck is running, stop the engine immediately and check the brake fluid level. In the event of an abnormal drop in the level, consult your dealer.

 **ORANGE ENGINE PREHEATING INDICATOR LAMP**

If preheating is required, the lamp comes on when the lift truck's ignition is switched on and should go out as soon as preheating is ended. If this lamp comes on while the lift truck is in operation, immediately stop the engine and seek the cause.

 **WATER IN FUEL INDICATOR LAMP**

If the indicator lamp comes on when the lift truck is running, stop the engine immediately and consult your dealer.

 **NO USED**

 **INDICATOR LIGHTS INDICATOR LAMP**

 **FRONT WHEEL ALIGNMENT INDICATOR LAMP**

 **REAR WHEEL ALIGNMENT LAMP**

 **FAST GEAR INDICATOR LAMP**

 **SLOW GEAR INDICATOR LAMP**

 **BLUE MAIN BEAM INDICATOR LAMP**

## 6B - SCREEN DISPLAY



UPPER SCREEN DISPLAY



LOWER SCREEN DISPLAY



SCROLL BUTTON



VALIDATION, RESET AND ERROR CODE BUTTON

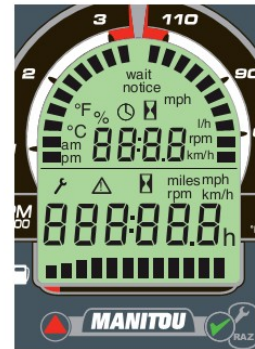

### UPPER SCREEN DISPLAY

Switch on the lift truck ignition, by default, the screen will show the time. Press the scroll button to switch from one screen to the other in turn.

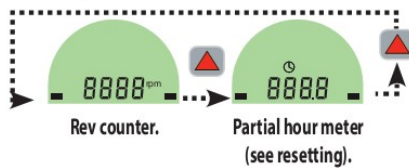

### SETTING THE TIME

- Display clock screen.
- Press the button for 2 seconds, choose the "24 hour" or "12 hour am/pm" clock with the button and confirm .
- Set the hours with the button and confirm .
- Set the minutes with the button and confirm .

### RESETTING THE PARTIAL HOUR METER

- Display the partial hour meter screen.
- Press the button for two seconds, resetting is confirmed by a beep.

### LOWER SCREEN DISPLAY

Switch on the lift truck ignition, by default, the screen will show the hour meter , i.e. the total number of hours the lift truck has been used. As soon as the engine is running, the flashing pictogram is displayed and the hour meter records the hours of operation.

### MAINTENANCE INTERVAL



NOTE: When the new lift truck is started, the maintenance key will logically be displayed to provide a reminder to replace the engine oil and the oil filter after the first 50 hours of operation (see: 3 - MAINTENANCE: SERVICING SCHEDULE).







The maintenance key appears on the hour meter screen 50 hours before the maintenance deadline and generates an audible beep.

- Press the button to display the time remaining before maintenance . In the event that the deadline is exceeded, the hours are shown with a plus sign.
- Press once more on the button to return to the hour meter screen. The maintenance key will be displayed for information.
- Contact your dealer to carry out the necessary maintenance operations and reset the maintenance interval.

NOTE: The frequency interval displayed by default is 500 hours, this interval can be modified. Please contract your dealer.

## ERROR CODES

The appearance of the pictogram  on the hour meter screen  together with the sounding of an audible beep, indicate that a fault has been detected by one of the lift truck's Electronic Control Units (ECU).

- Press the button  to display the information  on the upper screen, as well as the error code .
- If there are several error codes, press the button  to scroll through all the error codes.
- Press the button  again to return to the hour meter screen, the pictogram  will remain displayed as long as the required repairs have not been carried out.
- Contact your dealer, stating the error code or codes.

NOTE: A faulty fuse can generate several error codes. When "error codes" and "maintenance interval" are displayed together, the maintenance reminder time will appear at the end of the list.



## 7 - LONGITUDINAL STABILITY LIMITER AND WARNING DEVICE

### ⚠ IMPORTANT ⚠

*The operator must respect the lift truck's load chart, and the operating mode according to the attachment.*

This device warns the operator of the lift truck's longitudinal stability limits. However, lateral stability can reduce the load chart in the upper part, and this reduction is not detected by the device.

Depending on the type of work required, the longitudinal stability limiter and warning device allows the operator to operate the lift truck in complete safety.

UPDATED: In order to gain maximum advantage from the longitudinal stability limiter and warning device of your lift truck, contact your dealer to receive the most recent available version of the software.



#### "HANDLING" MODE (use with forks)

- By default, the device is in "HANDLING" MODE when the lift truck is started-up, except if "BUCKET" MODE has been selected before switching off the ignition.



#### "BUCKET" MODE (use with bucket)

- Place the lift truck in the transport position.
- Hold down the button, "BUCKET" MODE is confirmed by an audible beep and the lighting of the indicator lamp.
- Press this button again to return to "HANDLING" MODE.

NOTE: "BUCKET" MODE remains enabled as long as the mode is not changed by the operator, even after switching off the ignition.



#### "SUSPENDED LOAD" MODE (use with hoist) (offering a higher margin of error)

- Place the lift truck in the transport position.
- Hold down the button, the "SUSPENDED LOAD" MODE is confirmed by a beep and the lighting of the indicator lamp. Hydraulic inclination movements are neutralised, as well as the lifting movement when the longitudinal limit is reached (indicator lamp A8 lit).
- Press this button again or switch off the ignition with the ignition key to return to "HANDLING" MODE.

### A - VISUAL ALARMS

- A1 - A2 - A3: There is a significant reserve of longitudinal stability.
- A4 - A5: The lift truck is approaching the limit of longitudinal stability, move with care.
- A6: The lift truck is close to the limit for longitudinal stability. Drive carefully.
- A7: The lift truck is very close to the limit of longitudinal stability. Maneuver with extreme caution.
- A8: The lift truck is at the authorised limit of longitudinal stability.

The warning indicator lamp and a beep indicate a fault.

- To view this error code (see: 2 - DESCRIPTION: 3B - SCREEN DISPLAY).

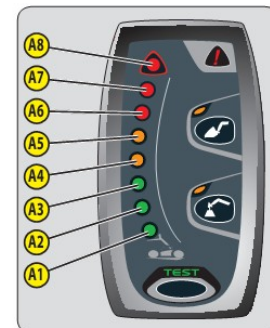

### B - HYDRAULIC MOVEMENT CUT-OFF

NOTE: Cut-off may be preceded by an automatic slowing of hydraulic movement.

#### "HANDLING" MODE

- A8: All "AGGRAVATING" hydraulic movements are cut-off. Only perform de-aggravating hydraulic movements in the following order: retract and raise the boom.

#### "BUCKET" MODE

- A8: The boom lowering and extension movements are cut-off, the other movements remain available.

#### "SUSPENDED LOAD" MODE

- A8: All "AGGRAVATING" and boom raising hydraulic movements are cut-off. Only the boom retraction hydraulic movement is available.

## C - HYDRAULIC MOVEMENT CUT-OFF CONFIGURATION

### ⚠ IMPORTANT ⚠

The cut-off of "AGGRAVATING" hydraulic movements has two possible configurations. Consult your dealer to change this configuration.

Your configuration can be identified simply by driving. If indicator lamp C1 is off, configuration 1 is enabled, indicator lamp C1 is lit, configuration 2 is enabled.

CONFIGURATION 1	HALTED	SLOW SPEED 1 to 3 km/h	SPEED > 3 km/h	TELESCOPE(S) IN RETRACTED POSITION
"HANDLING" MODE	A4-A5: Very slow intermittent sound alarm. A6: Slow intermittent sound alarm. A7: Fast intermittent sound alarm. A8: Very fast intermittent sound alarm.		No sound alarm.	No sound alarm. <b>The "AGGRAVATING" hydraulic movement cut-off function is disconnected.</b>
"BUCKET" MODE	A6: A beep upon passing into the red zone.			
"SUSPENDED LOAD" MODE	A4-A5: Very slow intermittent sound alarm. A6: Slow intermittent sound alarm. A7: Fast intermittent sound alarm. A8: Very fast intermittent sound alarm.		No sound alarm.	

CONFIGURATION 2	HALTED	SLOW SPEED 1 to 5 km/h	SPEED > 5 km/h	TELESCOPE(S) RETRACTED
"HANDLING" MODE	A4-A5: Very slow intermittent sound alarm. A6: Slow intermittent sound alarm. A7: Fast intermittent sound alarm. A8: Very fast intermittent sound alarm.	A7: Fast intermittent sound alarm. A8: Very fast intermittent sound alarm. <b>When indicator lamp C1 is lit, the "AGGRAVATING" hydraulic movement cut-off function is disconnected.</b>	No sound alarm. <b>When indicator lamp C1 is lit, the "AGGRAVATING" hydraulic movement cut-off function is disconnected.</b>	No sound alarm. <b>When indicator lamp C1 is lit, the "AGGRAVATING" hydraulic movement cut-off function is disconnected.</b> 
"BUCKET" MODE	A6: A beep upon passing into the red zone.	A6: A beep upon passing into the red zone. <b>When indicator lamp C1 is lit, the "AGGRAVATING" hydraulic movement cut-off function is disconnected.</b>	No sound alarm. <b>When indicator lamp C1 is lit, the "AGGRAVATING" hydraulic movement cut-off function is disconnected.</b>	
"SUSPENDED LOAD" MODE	A4-A5: Very slow intermittent sound alarm. A6: Slow intermittent sound alarm. A7: Fast intermittent sound alarm. A8: Very fast intermittent sound alarm.			

## D - DISABLING "AGGRAVATING" HYDRAULIC MOVEMENT CUT-OFF

### ⚠ IMPORTANT ⚠

Remain very vigilant during this operation. The only information available to the operator is the lift truck's dynamic stability.

In certain cases, in order to get out of a difficult situation, the operator can bypass this safety system. Button D temporarily disables the cutting-off of "AGGRAVATING" hydraulic movements.

- Hold down button D (indicator lamps C1 and D1 lamp will light (60 second time delay)), and at the same time perform the necessary "AGGRAVATING" hydraulic movement with extreme care.



## E - TESTING OF THE LONGITUDINAL STABILITY LIMITER AND WARNING DEVICE

- Short press the  button to verify at any time that the longitudinal stability alarm is working.
  - Correct operation: All the LEDs A1 to A8 light for two seconds and an audible beep is sounded.

NOTE: This test does not check the proper adjustment of the longitudinal stability limiter that must be inspected daily or after every 10 hours of service (see: 3 - MAINTENANCE: A - DAILY OR EVERY 10 HOURS SERVICE).

## F - STRAIN GAUGE

### ⚠ IMPORTANT ⚠

Disassembly or calibration of the strain gage is prohibited, this must only be done by specially trained personnel, consult your dealer.



647511 (09/09/2016)  
MT 625 H EASY 49 K3BA S1

## 8 - SWITCHES

NOTE: The location of the switches may vary depending on the options.

### A - WARNING LIGHTS

### B - REAR FOG LIGHTS

### C - OPTION REVOLVING LIGHT

### D - OPTION FRONT AND REAR WORKING

### E - OPTION

### F - OPTION

### G - NEUTRALIZATION OF HYDRAULIC MOVEMENTS

When driving on the road, it is strongly recommended (mandatory in Germany) that you cut-off all the hydraulic movements. The indicator lamp shows when it is in use.

### H - OPTION

### I - PARKING BRAKE

To connect the parking brake, press the bottom of the switch. The indicator lamp shows when it is in use. To disconnect the parking brake, press the top of the switch.

### J - DISABLING THE "AGGRAVATING" HYDRAULIC MOVEMENT CUT-OFF

See: 2 - DESCRIPTION: 7 - LONGITUDINAL STABILITY LIMITER AND WARNING DEVICE.

### K - ATTACHMENT HYDRAULIC LOCKING OPTION

See: 2 - DESCRIPTION: DESCRIPTION AND USE OF THE OPTIONS.

### L - OPTION

### M - OPTION

### N - INCLINATION MOVEMENT NEUTRALISATION

Cuts carriage reverse and forward tilt movements. The indicator lamp shows when it is in use.

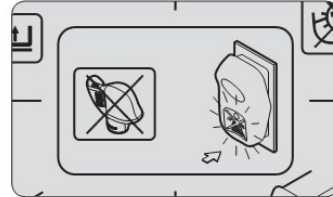

## 9 - ARMREST AND STORAGE

- Lift the armrest 1 to access the storage.



## 10 - FUSES AND RELAYS IN THE CAB

A fuse function file and a relay function file give a quick indication of the use of the panel's components described below.

- Lift the armrest.
- Remove access panel 1 to gain access to the fuses and relays, Replace a used fuse with a new fuse of the same quality and capacity. Never reuse a repaired fuse.

### MINIFUSE

- F1 - Control instrument module (5A).
- F2 - Alternator excitation (5A).  
Longitudinal stability limiter and warning device (5A).  
ECM wake-up (5A).
- F3 - Diagnostic socket (5A).  
Anti-theft predisposition(5A).
- F4 - Transmission electronic control unit (10A).  
Seat switch (10A).  
Telescoping movements and attachment control (10A).  
Negative parking brake electrovalve (10A).  
Hydraulic movement cut-off (10A).
- F5 - 12V connector (15A).  
OPTION Car radio (15A).
- F6 - Driver presence on seat (10A).  
Boom retraction and angle sensors (10A).
- F7 - Hydraulic electronic control unit power supply (10A).
- F8 - Disable aggravating hydraulic movement cut-off (5A).  
OPTION attachment hydraulic locking (7,5A).
- F9 - Stoplight relay power supply (10A).  
Reversing light relay power supply (10A).  
OPTION Reverse buzzer alarm relay supply (10A).
- F10 - Wheel alignment (2A).
- F11 - Flashing unit (15A).
- F12 - Rear fog lights (5A).
- F13 - OPTION
- F14 - Rotating beacon light (7,5A).
- F15 - OPTION
- F16 - OPTION
- F17 - Rear windscreen wiper and washe
- F18 - Front windscreen wiper and windscreen washer (15A).
- F19 - Power supply F27-F28-F29-F30 (30A).
- F20 - Heating (20A).
- F21 - Left sidelights (3A).
- F22 - Right sidelight (3A).
- F23 - Low beam (15A).
- F24 - Main beam (15A).
- F25 - Right indicator lights (7,5A).
- F26 - Left indicator lights (7,5A).
- F27 - OPTION
- F28 - OPTION
- F29 - OPTION
- F30 - Front and rear working lights (20A).
- F31 - Lighting, horn and indicator switch (20A).
- F32 - Hazard warning lights (15A).
- F33 - Diagnostic socket (+) permanent (5A).  
Anti-theft pre-disposition (+) permanent (5A).
- F34 - Horn (7,5A).  
OPTION Ceiling light (7,5A).
- F35 - OPTION Car radio (+) permanent (10A).
- F36 - Hydraulic electronic control unit power supply (3A).
- F37 - Rear windscreen wiper (+) permanent (10A).
- F38 - Front windscreen wiper (+) permanent (15A).
- F39 - OPTION
- F40 - OPTION

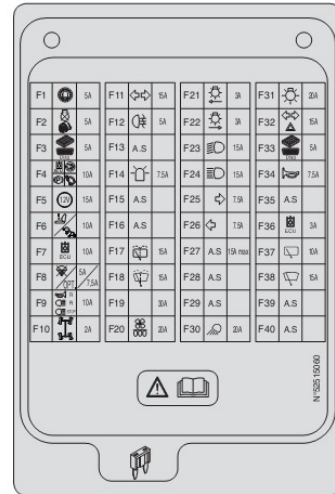

- F61 - power (+) battery control instrument module (2A).
- F62 - power (+) battery (2A).
- F63 - OPTION.
- F64 - OPTION.

#### RELAYS

- K1 - OPTION.
- K2 - Reversing light relay.  
OPTION Reversing sound alarm relay.
- K3 - Stoplight relay.
- K4 - OPTION.
- K5 - OPTION.
- K6 - OPTION.
- K7 - OPTION.
- K8 - Flashing unit.

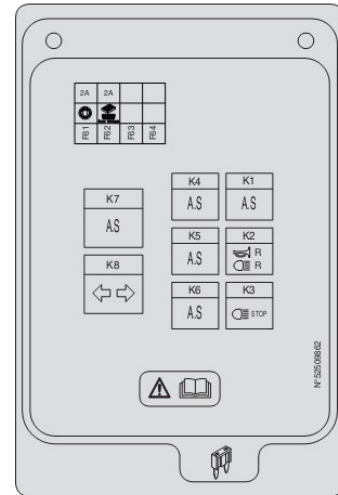

### 11 - FUSES AND RELAYS UNDER THE ENGINE BONNET

- Open engine bonnet 1 in order to gain access to the fuses and relays. Replace a used fuse with a new fuse of the same quality and capacity. Never reuse a repaired fuse.

#### RELAYS

- K20 - Engine preheating relay.
- K22 - Starter control relay.

#### MAXIFUSE

- F41 - Engine computer power supply (20A).
- F42 - Ignition switch (60A).
- F43 - Alternator (70A).
- F44 - Power supply for fuses in the cab (50A).
- F45 - Starting relay power supply (30A).
- F46 - Engine pre-heating (40A).

#### MINIFUSE

- F51 - Engine EGR valve power supply (5A).
- F52 - Dashboard power supply (3A).
- F53 - Starter relay K22 control + engine computer data (5A).
- F55 - Engine computer control power supply (5A).

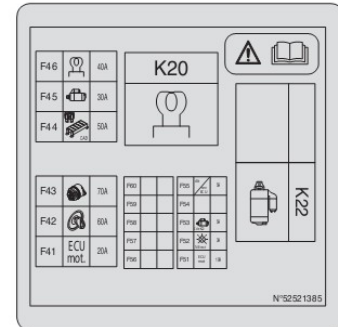
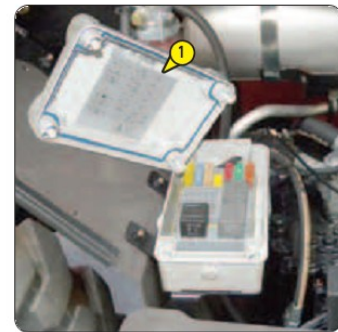

## 12 - CIGARETTE LIGHTER

For 12V appliance and max. amperage 15A.

## 13 - LIGHTING, HORN AND INDICATOR LIGHT SWITCH

The switch controls the visual and sound alarms.

- A - All lights are off, the indicator lights do not flash.
- B - The right hand indicator lights flash.
- C - The left hand indicator lights flash.
- D - The sidelights and the rear lights are on.
- E - The dipped headlights and the rear lights are on.
- F - The main beam headlights and the rear lights are on.
- G - Headlight signal.

Pressing the end of the switch sounds the horn.

NOTE: Positions D - E - F - G can be used without switching on the ignition.

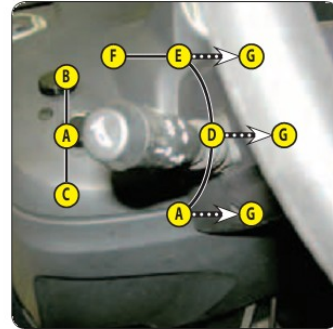

## 14 - FRONT AND REAR WINDSCREEN WIPER SWITCH

FRONT WINDSCREEN WIPER

- A - Front windscreen wiper stop.
- B - Front windscreen wiper low speed.
- C - Front windscreen wiper high speed.
- D - Front windscreen wiper intermittent control.
- E - Front windscreen washer, pulse-driven.

REAR WINDSCREEN WIPER

- F - Rear windscreen wiper stop.
- G - Rear windscreen wiper.
- H - Rear windscreen washer, pulse-driven.

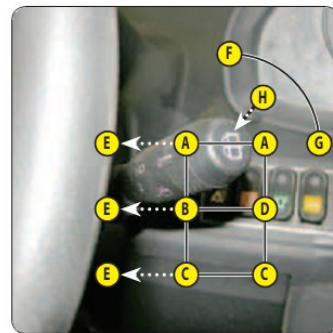

## 15 - FUNCTION FILES

These files contain, among other things, the description of the hydraulic controls and the load charts for the attachments used on the lift truck.

## 16 - HYDRAULIC CONTROLS

### ⚠ IMPORTANT ⚠

*Do not attempt to alter the hydraulic system pressure. In the event of malfunction, contact your dealer. ANY ALTERATION MAY RENDER THE WARRANTY NULL AND VOID.*

*Operate the hydraulic controls gently and smoothly to avoid accidents caused by jerking of the lift truck.*

NOTE: When driving on the road, it is highly recommended (mandatory in Germany) that you cut-off all the hydraulic movements (see: 2 - DESCRIPTION: 8 - SWITCHES).

- A - Lifting and tilting control lever.
- B - Telescoping control button.
- C - Attachment control button.



### LIFTING THE LOAD

- The lever A backwards when lifting.
- The lever A forwards when lowering.

### TILT OF CARRIAGE

- The lever A to the left for reverse tilt.
- The lever A to the right for forward tilt.

### TELESCOPING



- Button B forwards for extending.
- Button B backwards for retracting.



### ATTACHMENT

- Button C forwards or backwards.



### ADJUSTMENT OF ATTACHMENT HYDRAULIC FLOW RATE

- Switch on lift truck ignition.

- Select the attachment circuit hydraulic flow rate screen  with the scroll button . The screen displays, in turn, the hydraulic flow rate stored in the memory of circuit B (without "-" sign) and of circuit A (with "-" sign).

- Press the button  for two seconds, the screen  will appear on the lower screen display.
- Turn button C towards the front to select a hydraulic flow rate for circuit B of between 10 % and 100 %.

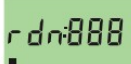
- Hold button C at the desired flow rate and confirm with the button .



- The screen  appears on the lower screen display.
- Turn button C towards the back to select a hydraulic flow rate for circuit A between -10 % and -100 %.
- Hold button C at the desired flow rate and confirm with the  button.

- The hour meter screen  appears on the lower display screen, confirming that adjustment is completed.

### GEAR SELECTION

Gears can be selected while driving.

Buttons 1 and 2 are used to select a gear.

- FAST GEAR: For driving on the road. Press button 1, the fast gear indicator lamp  comes on.
- SLOW GEAR: For handling operations. Press button 2, the slow gear indicator lamp  comes on.

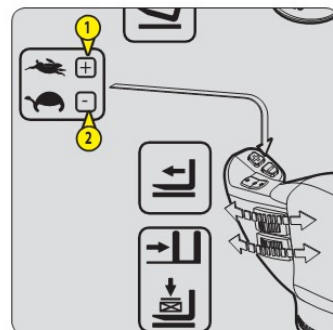
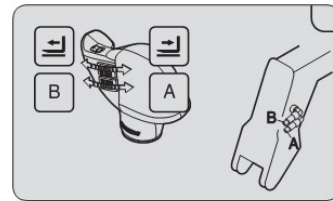
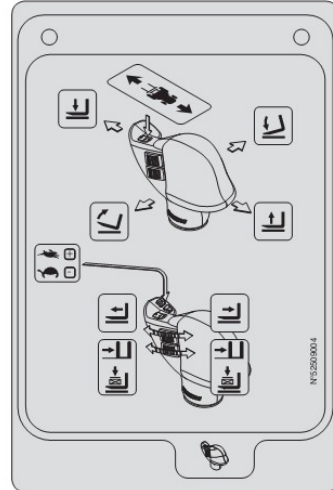

647511 (09/09/2016)  
MT 625 H ERSY 49 K53A S1

## 17 - ACCELERATOR PEDAL

---

## 18 - SERVICE BRAKE PEDAL AND TRANSMISSION CUT-OFF

---

The pedal acts on the front wheels by means of a hydraulic brake system to slow down and stop the lift truck. During clearance travel it enables the transmission to be cut off progressively thus allowing a gradual approach (delicate handling) with all the engine power.



## 19 - FORWARD/NEUTRAL/REVERSE GEAR SELECTION

---

When operating this control, the lift truck should be traveling at slow speed and not accelerating.

FORWARD: Flip the switch forward (position A).

REVERSE: Flip the switch backward (position B). An OPTIONAL reversing light and audible reversing alarm indicate that the lift truck is traveling in reverse.

NEUTRAL: If indicators   or  are flashing, pass the forward/reverse selector back through neutral (position C).

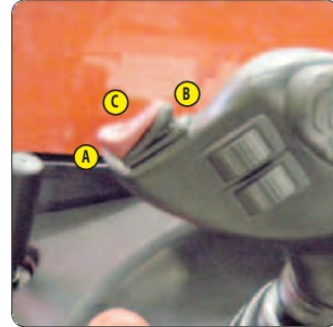





### SAFETY FOR MOVING THE LIFT TRUCK

Authorization to move the lift truck is controlled by an electronic unit. The operator must observe the following sequence to move the truck forwards or backwards:

- 1 - sit down correctly in the driver's seat,
- 2 - release the parking brake,
- 3 - engage forward or reverse movement.

To stop the lift truck, he must observe the following sequence:

- 1 - set the forward/reverse selector to neutral,
- 2 - engage the parking brake,
- 3 - get out of the lift truck.

- If the operator leaves the driving cab with forward or reverse engaged, the screen  **SERV** will appear and beeps will sound for two seconds. During this time, the operator can sit back down in the seat and continue advancing or reversing. When this time is exceeded, the forward/reverse selector will switch to neutral and the indicators   or  will flash. The operator must sit back down and pass the forward/reverse selector back through neutral.



## 20 - STEERING SELECTION

### A - GREEN WHEEL ALIGNMENT INDICATOR LAMPS



*Before selecting one of the three possible steering positions, bring all 4 wheels into alignment with the lift truck axis.  
Never change the steering mode whilst driving.*

These green lamps come on to indicate the alignment of the wheels in relation to the lift truck. The A1 indicator lamp for the front wheels and the A2 indicator lamp for the rear wheels.

### B - STEERING SELECTION LEVER

- B1 - Front drive wheels (highway traffic).
- B2 - Front and rear drive wheels in opposite direction (short steering lock).
- B3 - Front and rear drive wheels in the same direction (crab steering).

### CHECKING WHEEL ALIGNMENT



*Before driving on roads, it is necessary to check the alignment of the rear wheels and to drive in front wheel steering mode.*

*The alignment of the rear wheels must be regularly checked done using the green indicator lamps, while driving the lift truck.*

*In case of anomalies, consult your dealer.*

- Shift the steering selection lever B into position B2 (short steering lock).
- Turn the steering wheel and bring the rear wheels into alignment until the A2 indicator lamp comes on.
- Shift the steering selection lever B into position B1 (highway traffic).
- Turn the steering wheel and bring the front wheels into alignment until the A1 indicator lamp comes on.

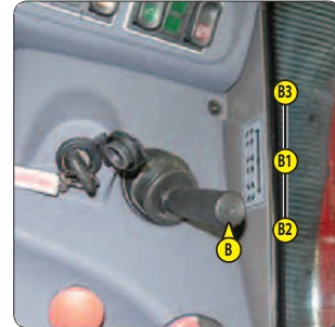
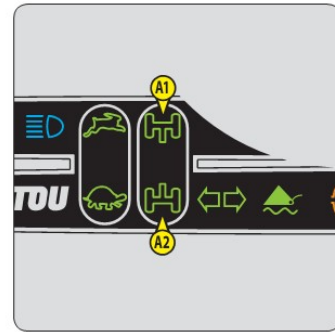

## 21 - HEATER CONTROL

### A - FAN CONTROL

This 3-speed control allows the air to be ventilated through the air vents.

### B - TEMPERATURE CONTROL

Adjusts the temperature inside the cab.

- B1 - The fan pumps in the air at ambient temperature.
- B2 - The fan pumps in warm air.

The intermediate positions allow the temperature to be adjusted.

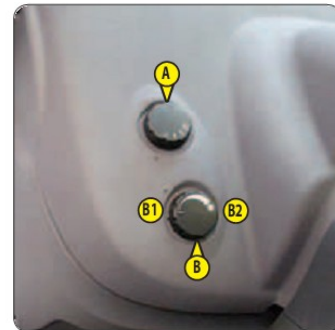

## **22 - HEATING VENTS**

These swiveling heating vents, which can be shut off, allow you to direct and adjust the flow inside the cab.

## **23 - DEMIST VENTS**

These vents allow the front windscreen and side windows to be demisted. For optimum efficiency, shut off the heating vents.

## **24 - LEVEL INDICATOR**

Enables the operator to check that the lift truck is in the horizontal position.



## **25 - DOOR LOCK**

Two keys are provided with the lift truck to enable the cabin to be locked.

## **26 - DOOR WINDOW OPENING HANDLE**

## **27 - DOOR WINDOW RELEASE BUTTON**

## **28 - HANDLE FOR REAR WINDOW OPENING**

EMERGENCY EXIT

Use the rear window as an emergency exit, if it is impossible to leave the cab by the door.

## **29 - DOCUMENT HOLDER NET**

Make sure that the operator's manual is in the right place, i.e. in the document holder net.

NOTE: An OPTIONAL waterproof document-holder exists.

## **30 - STEERING WHEEL ADJUSTMENT LEVER**

This handle enables the angle and height of the steering wheel to be adjusted.

- Pull the knob 1 backwards.
- Adjust the steering wheel to the desired position.
- Push the knob back to lock the steering wheel in position.



### 31 - FRONT HEADLIGHTS

- A - Left front indicator.
- B - Left front dipped beam headlight.
- C - Left front main beam headlight.
- D - Left front sidelight.
- E - Right front indicator.
- F - Right front dipped beam headlight.
- G - Right front main beam headlight.
- H - Right front sidelight.



### 32 - REAR LIGHTS

- A - Left rear indicator.
- B - Left rear stoplight.
- C - Left rear headlight.
- D - Rear fog light.
- E - Reversing light.
- F - Rear right headlight.
- G - Right rear stoplight.
- H - Right rear indicator light.

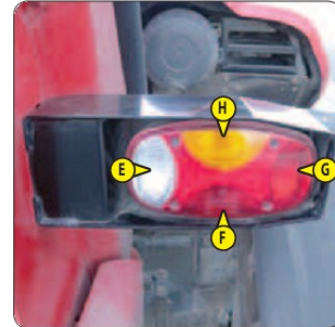
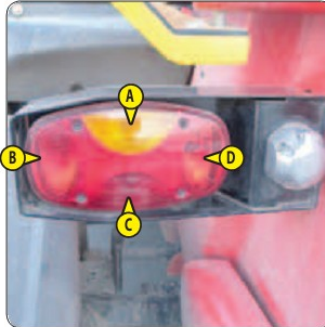

### 33 - ROTATING BEACON LIGHT

The magnetic rotating beacon light must be clearly visible on the roof of the cab and plugged-in to socket 1.



### 34 - CEILING LIGHT (OPTION)

### 35 - ROOF WINDSCREEN WIPER SWITCH (OPTION)

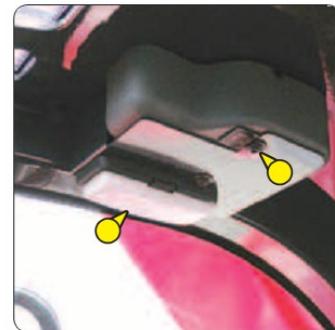

### 36 - SUN VISOR (OPTION)

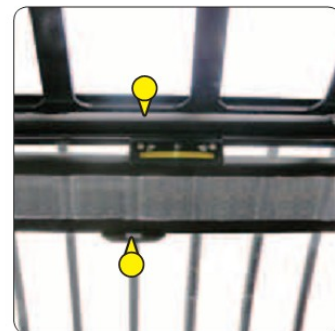

647511 (09/09/2016)  
MT 625 H E6SY 49 K5B3A 51

**37 - DIAGNOSTIC PLUG**

---



**38 - BOOM SAFETY WEDGE**

---



## TOWING PIN AND HOOK

### ⚠ IMPORTANT ⚠

*Do not tow a trailer or an attachment that is not in perfect working order.*

*Using a trailer that is not in good condition may affect the steering and braking of the lift truck and therefore the safety of the whole unit.*

*If a third party helps in coupling or uncoupling the trailer, this person must remain visible to the driver at all times and must wait until the lift truck has stopped, the handbrake is on and the engine is switched off before performing the operation.*

Located at the rear of the lift truck, this device is used to attach a trailer. Its capacity is limited for each lift truck by the authorized gross vehicle weight, tractive effort and maximum vertical force on the coupling point. This information is indicated on the manufacturer's plate affixed to each lift truck (see: 2 - DESCRIPTION: IDENTIFICATION OF THE LIFT TRUCK).

- To use a trailer, see current regulations in your country (maximum running speed, braking, maximum weight of trailer, etc.).
- Verify the trailer's condition before using it (tire condition and pressures, electrical connection, hydraulic hose, brake system...).

### 1 - TOWING PIN

#### ⚠ IMPORTANT ⚠

*Be careful not to get your fingers caught or crushed during this operation.*

*Do not forget to put the cotter pin back in place.*

*When uncoupling, make sure that the trailer is supported independently.*

#### COUPLING AND UNCOUPLING THE TRAILER

- To couple the trailer, position the lift truck as close as possible to the trailer ring.
- Apply the handbrake on and switch off the engine.
- Remove the clip 1, lift the trailer pin 2 and place or remove the trailer ring.

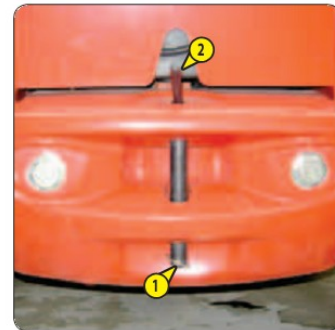

### 2 - REAR ELECTRIC SOCKET

Connect the male plug to the female socket 1 on the lift truck and make sure the lights of the trailer or the light bar are working properly.

- A - Left rear indicator.
- B - OPTION Rear fog lights.
- C - Ground.
- D - Right rear indicator.
- E - Right rear headlight.
- F - Rear stoplight.
- G - Rear left headlight + number plate.

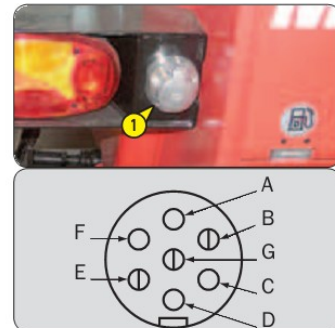

### 3 - COUPLING FITTING (OPTION)

#### ⚠ IMPORTANT ⚠

*Be careful not to get your fingers caught or crushed during this operation.*

*Do not forget to put the cotter pin back in place.*

*When uncoupling, make sure that the trailer is supported independently.*

#### COUPLING AND UNCOUPLING THE TRAILER

- To couple the trailer, position the lift truck as close as possible to the trailer ring.
- Switch off the engine.
- Remove the clip 1, lift the trailer pin 2 and place or remove the trailer ring.

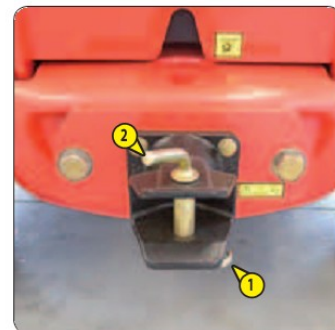

## DESCRIPTION AND USE OF THE OPTIONS

- 1 - PREHEAT ROD
- 2 - MODCOD ANTI-THEFT SYSTEM
- 3 - FINTRONIC ANTI-START SYSTEM
- 4 - NUMBER PLATE LIGHTING
- 5 - ANGULAR SECTOR ON BOOM
- 6 - EXTERIOR DRAIN-BACK
- 7 - ATTACHMENT HYDRAULIC LOCKING
- 8 - LIFTING RING ON SINGLE CARRIAGE

### 1 - PREHEAT ROD

Enables the engine block to be kept warm during prolonged periods of stoppage and thus improves engine starting.

#### SUPPLY CHARACTERISTICS OF PREHEATING SYSTEM:

- Rated power supply voltage range: 220-240V; 50-60Hz
- Current consumed: 4,5A
- Class 1 equipment
- Equipment connectable only to TT or TN supply systems
- Installation category 2

#### ENVIRONMENTAL CONDITIONS FOR USE:

- Maximum ambient temperature for using preheating: +25°C
- Pollution level 2

#### CONDITIONS FOR CONNECTION AND USE OF PREHEATING:

- The preheating system should not be used for an external ambient temperature higher than +25°C.
- It is essential that the power supply to the preheating system:
  - Is effected with a cable that conforms to the installation standards in force and contains a protective earth conductor.
  - Contains an appropriate sectioning system.
  - Incorporates an appropriate safety system against short circuits (fuses or circuit breaker) and a differential circuit breaker with 30 mA sensitivity.
- Only connect to and disconnect from the power supply while the unit is switched off and the engine is stopped.



### 2 - MODCOD ANTI-THEFT SYSTEM

#### OPERATION

- Switch on lift truck ignition, red LED 1 will flash.
- Enter your user code followed by "V" to validate, green LED 2 will light.
- Start the lift truck within the next 60 seconds; otherwise the anti-theft system will be reactivated and red LED 1 will flash.

NOTE: If you make a mistake when entering the code, press key "A" to cancel and re-enter the code in full. If you wait more than 5 seconds between key presses, the code entry procedure will be aborted, the anti-theft system will be reactivated and the red LED will flash.



### 3 - FINTRONIC ANTI-START SYSTEM

#### OPERATION

- Switch on the lift truck and set the black key A next to the antenna B (maximum 80 mm).
- Wait a few seconds for red LED C to go out before starting the lift truck.

NOTE: You can restart the lift truck within 20 seconds of stopping it: after this time, the anti-start system reacts and red LED C flashes.

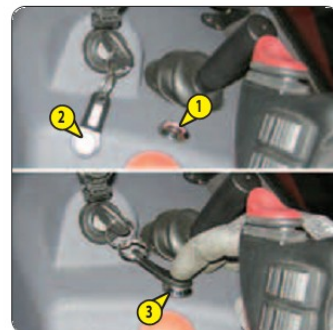

#### **4 - NUMBER PLATE LIGHTING**

---



#### **5 - ANGULAR SECTOR ON BOOM**

---

The angular sector displays the boom angle, and thus improves the reading of the load charts.



#### **6 - EXTERIOR DRAIN-BACK**

---

Enables connection of an attachment for which drain-back is required.



## 7 - ATTACHMENT HYDRAULIC LOCKING

Enables the attachment to be locked onto the carriage and a hydraulic attachment to be used by the same hydraulic circuit.

### ATTACHMENT LOCKING CONTROL

- Set valve 1 to position A and press switch 2 at position B (indicator lamp on).
- Push switch 3 forward to lock the attachment and backward to release it.

**⚠ IMPORTANT ⚠**

*After locking the attachment, return switch 2 to position A (indicator lamp off) to prevent accidental release of the attachment.*

### HYDRAULIC ATTACHMENT CONTROL

- Set the valve to position B and press switch 2 at position B (indicator lamp on).
- Push switch 3 forward or backward.

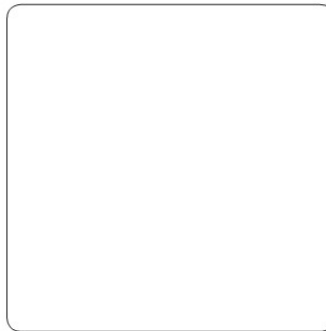
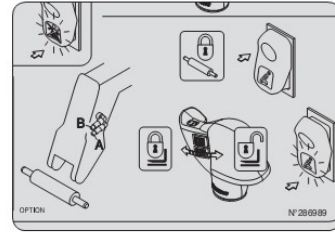



## 8 - LIFTING RING ON SINGLE CARRIAGE

### CONDITIONS OF USE



Follow the instructions given in your lift truck's instruction manual (see: 1 - OPERATING AND SAFETY INSTRUCTIONS ON HANDLING LOADS), in addition to those given below.

- The lifting ring must be used WITHOUT FORKS AND ATTACHMENTS, but the angle of inclination of the carriage must be same as when the forks are used in the horizontal position.
- Check the maximum permitted angle, which is 45°.
- Do not change the angle of the carriage while using the lifting ring.
- The lifting hook, the chains and slings shall have a minimum capacity of 3000 kg with a factor of safety against breakage of 4.

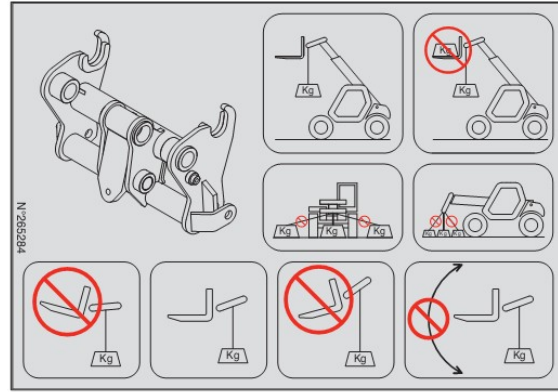

### LOAD CHARTS AND FUNCTION SHEETS



The load charts are given for use without forks and without attachments.

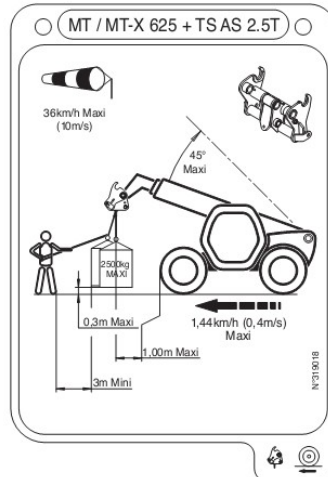
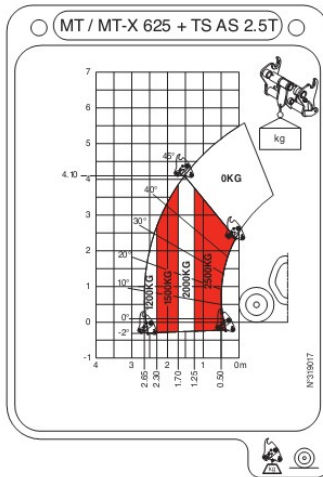

# **3 - MAINTENANCE**



## TABLE OF CONTENTS

### 3 - MAINTENANCE

<u>ORIGINAL MANITOU SPARE PARTS AND EQUIPMENT</u>	<u>4</u>
<u>FILTERS CARTRIDGES AND BELTS</u>	<u>5</u>
<u>LUBRICANTS AND FUEL</u>	<u>6</u>
<u>SERVICING SCHEDULE</u>	<u>8</u>
<u>A - DAILY OR EVERY 10 HOURS OF SERVICE</u>	<u>10</u>
<u>B - EVERY 50 HOURS OF SERVICE</u>	<u>14</u>
<u>C - EVERY 250 HOURS OF SERVICE</u>	<u>18</u>
<u>D - EVERY 500 HOURS OF SERVICE OR EVERY YEAR</u>	<u>20</u>
<u>E - EVERY 1000 HOURS OF SERVICE OR EVERY TWO YEARS</u>	<u>24</u>
<u>F - EVERY 2000 HOURS OF SERVICE OR EVERY TWO YEARS</u>	<u>26</u>
<u>G - OCCASIONAL MAINTENANCE</u>	<u>28</u>

## ORIGINAL MANITOU SPARE PARTS AND EQUIPMENT

OUR LIFT TRUCKS MUST BE SERVICED USING ORIGINAL MANITOU PARTS.

### BY ALLOWING THE USE OF NON ORIGINAL MANITOU PARTS, YOU RISK:

---

- Legally -to be held responsible in the event of an accident.
- Technically - to cause operating malfunctions or shorten the life of the lift truck.

**⚠ IMPORTANT ⚠**

**THE USE OF COUNTERFEIT PARTS OR COMPONENTS NOT APPROVED BY THE MANUFACTURER,  
WILL CAUSE YOU TO LOSE THE BENEFIT OF THE CONTRACTUAL GUARANTEE.**

### BY USING ORIGINAL MANITOU PARTS FOR MAINTENANCE OPERATIONS, YOU BENEFIT FROM OUR KNOW-HOW

---

Through its network, MANITOU provides the user with,

- Know-how and competence.
- The guarantee of high-quality work.
- Original replacement parts.
- Help with preventive maintenance.
- Efficient help with diagnosis.
- Improvements due to experience feedback.
- Operator training.
- Only the MANITOU network has detailed knowledge of the design of the lift truck and therefore the best technical ability to provide maintenance.

**⚠ IMPORTANT ⚠**

**ORIGINAL REPLACEMENT PARTS ARE DISTRIBUTED EXCLUSIVELY BY MANITOU AND ITS DEALER NETWORK.  
The dealer network list is available on the MANITOU web site [www.manitou.com](http://www.manitou.com)**

## FILTERS CARTRIDGES AND BELTS

### ENGINE

ENGINE OIL FILTER  
Part number: 749613  
Change: 500 H



ALTERNATOR BELT  
Part number: 941672  
Change: 500 H

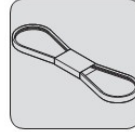

DRY AIR FILTER CARTRIDGE  
Part number: 563416  
Clean: 50 H  
Change: 1000 H



CYCLONIC PRE-FILTER (OPTION)  
Part number: 224713  
Clean: 10 H

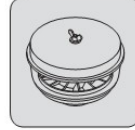

SAFETY DRY AIR FILTER CARTRIDGE  
Part number: 563415  
Change: 2000 H



FUEL PRE-FILTER  
Part number: 941742  
Clean: 250 H



FUEL FILTER  
Part number: 795541  
Change: 500 H

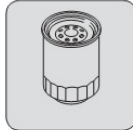

### HYDRAULIC SYSTEM

HYDRAULIC RETURN OIL FILTER CARTRIDGE  
Part number: 686236  
Change: 500 H



BRAKE ACCUMULATOR UNIT FILTER  
Part number: 746308  
Change: 2000 H



### CAB

CAB FAN FILTER  
Part number: 750306  
Clean: 50 H  
Change: 250 H

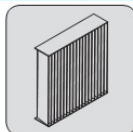

## LUBRICANTS AND FUEL

### ⚠ IMPORTANT ⚠

- USE THE RECOMMENDED LUBRICANTS AND FUEL:**
- For topping up, oils may not be miscible.
  - For oil changes, MANITOU oils are perfectly appropriate.

### DIAGNOSTIC ANALYSIS OF OILS

If a service or maintenance contract has been organized with the dealer, a diagnostic analysis of engine, transmission and axle oils may be requested depending on the rate of use.

### (\* ) REQUIRED FUEL SPECIFICATION

Use a high-quality fuel to obtain optimal performance of the engine.

- EN590 diesel fuel (sulfur content < 10ppm)
- ASTM D975 diesel fuel (sulfur content < 10ppm)

### RECOMMENDED LUBRICANT

ENGINE		RECOMMENDED LUBRICANT									
PARTS TO BE LUBRICATED	CAPACITY	RECOMMENDED LUBRICANT									
ENGINE	10,2 Liters	MANITOU PREMIUM OIL 15W40 API CI4									
		-40°C	-30	-20	-10	0	+10	+20	+30	+40	+50°C
COOLING CIRCUIT	12 Liters	COOLING LIQUID -35°C									
		-40°C	-30	-20	-10	0	+10	+20	+30	+40	+50°C
FUEL TANK	63 Liters	DIESEL FUEL (*)									
		-40°C	-30	-20	-10	0	+10	+20	+30	+40	+50°C
BOOM		RECOMMENDED LUBRICANT									
PARTS TO BE LUBRICATED	CAPACITY	RECOMMENDED LUBRICANT									
BOOM PADS		MANITOU BLACK MULTI-PURPOSE LUBRICANT									
		-40°C	-30	-20	-10	0	+10	+20	+30	+40	+50°C
GREASING OF THE BOOM		MANITOU BLUE MULTI-PURPOSE LUBRICANT									
		-40°C	-30	-20	-10	0	+10	+20	+30	+40	+50°C
HYDRAULIC SYSTEM		RECOMMENDED LUBRICANT									
PARTS TO BE LUBRICATED	CAPACITY	RECOMMENDED LUBRICANT									
		-40°C	-30	-20	-10	0	+10	+20	+30	+40	+50°C
HYDRAULIC OIL TANK	85 Liters	ISO VG 100 ISO VG 68 MANITOU ISO VG 46 HYDRAULIC OIL ISO VG 37 ISO VG 32									
		-40°C	-30	-20	-10	0	+10	+20	+30	+40	+50°C
BRAKE		RECOMMENDED LUBRICANT									
PARTS TO BE LUBRICATED	CAPACITY	RECOMMENDED LUBRICANT									
BRAKE CIRCUIT	1 Liter	MANITOU MINERAL BRAKE FLUID									
		-40°C	-30	-20	-10	0	+10	+20	+30	+40	+50°C
CAB		RECOMMENDED LUBRICANT									
PARTS TO BE LUBRICATED	CAPACITY	RECOMMENDED LUBRICANT									
WINDSCREEN WASHER TANK	4 Liters	WINDSCREEN WASHER LIQUID									
		-40°C	-30	-20	-10	0	+10	+20	+30	+40	+50°C
FRONT AXLE		RECOMMENDED LUBRICANT									
PARTS TO BE LUBRICATED	CAPACITY	RECOMMENDED LUBRICANT									
FRONT AXLE DIFFERENTIAL	4 Liters	SPECIAL MANITOU OIL FOR IMMERSSED BRAKES									
		-40°C	-30	-20	-10	0	+10	+20	+30	+40	+50°C
TRANSFER GEAR BOX FRONT WHEEL REDUCING GEAR	0,75 Liter 2 x 0,8 Liter	MANITOU SAE80W90 MECHANICAL TRANSMISSION OIL									
		-40°C	-30	-20	-10	0	+10	+20	+30	+40	+50°C
FRONT WHEEL REDUCING GEAR PIVOTS		MANITOU BLUE MULTI-PURPOSE LUBRICANT									
		-40°C	-30	-20	-10	0	+10	+20	+30	+40	+50°C

647511 (09/09/2016)  
MT 625 H E6SY 49 K53A 51

<b>REAR AXLE</b>												
<b>PARTS TO BE LUBRICATED</b>		<b>CAPACITY</b>	<b>RECOMMENDED LUBRICANT</b>									
REAR AXLE DIFFERENTIAL		3,8 Liters	<b>SPECIAL MANITOU OIL FOR IMMersed BRAKES</b>									
			-40°C	-30	-20	-10	0	+10	+20	+30	+40	+50°C
REAR WHEEL REDUCING GEAR		2 x 0,9 Liter	<b>MANITOU SAE80W90 MECHANICAL TRANSMISSION OIL</b>									
			-40°C	-30	-20	-10	0	+10	+20	+30	+40	+50°C
REAR WHEEL REDUCING GEAR PIVOTS REAR AXLE OSCILLATION			<b>MANITOU BLUE MULTI-PURPOSE LUBRICANT</b>									

## PACKAGING

<b>OIL</b>							
<b>PRODUCT</b>	<b>PACKAGING / REFERENCE</b>						
	<b>1 LITER</b>	<b>2 LITERS</b>	<b>5 LITERS</b>	<b>20 LITERS</b>	<b>55 LITERS</b>	<b>209 LITERS</b>	
- MANITOU PREMIUM OIL 15W40 API C14			895831	895832	895833	895834	
- MANITOU ISO VG 46 HYDRAULIC OIL			545500	582297	546108	546109	
- MANITOU MINERAL BRAKE FLUID	490408					4500078	
- SPECIAL MANITOU OIL FOR IMMersed BRAKES			545976	582391	947918	894257	
- MANITOU SAE80W90 MECHANICAL TRANSMISSION OIL		499237	720184	546330	546221	546220	

<b>GREASE</b>							
<b>PRODUCT</b>	<b>PACKAGING / REFERENCE</b>						
	<b>400 ML</b>	<b>400 GR</b>	<b>1 KG</b>	<b>5 KG</b>	<b>20 KG</b>	<b>50 KG</b>	
- MANITOU BLACK MULTI-PURPOSE LUBRICANT		947766	161590			499235	
- MANITOU BLUE MULTI-PURPOSE LUBRICANT		161589	720683	554974	499233	489670	

<b>LIQUID</b>							
<b>PRODUCT</b>	<b>PACKAGING / REFERENCE</b>						
	<b>1 LITER</b>	<b>2 LITERS</b>	<b>5 LITERS</b>	<b>20 LITERS</b>	<b>55 LITERS</b>	<b>210 LITERS</b>	
- COOLING LIQUID -35°C			894967	894968		894969	
- WINDSCREEN WASHER LIQUID	490402		486424				



# SERVICING SCHEDULE

## ⚠ IMPORTANT ⚠

(1): MANDATORY 500 HOUR OR 6 MONTH SERVICE. This service must be carried out after approximately the first 500 hours of operation or within the 6 months following the start-up of the machine (whichever occurs first).

(2): The engine oil and engine oil filter must be replaced after the first 50 hours of operation and every 500 hours of operation thereafter.

(3): Every 10 hours during the first 50 hours then a final time at 250 hours.

(4): Contact your dealer.

(5): In the event of using diesel fuel with a sulfur content > 5000ppm, halve the filter and engine oil replacement frequency.

A = ADJUST, C = CHECK, G = GREASE, N = CLEAN, P = BLEED, R = REPLACE, V = DRAIN	PAGE	(1)	DAILY OR EVERY 10 HOURS OF SERVICE	EVERY 50 HOURS OF SERVICE	EVERY 250 HOURS OF SERVICE	EVERY 500 HOURS OF SERVICE OR EVERY YEAR	EVERY 1000 HOURS OF SERVICE EVERY TWO YEARS	EVERY 1500 HOURS OF SERVICE EVERY TWO YEARS	EVERY 2000 HOURS OF SERVICE EVERY TWO YEARS	EVERY 3000 HOURS OF SERVICE	EVERY 4000 HOURS OF SERVICE	OCCASIONAL
<b>ENGINE</b>												
- Engine oil level	3-10	C	C									
- Cooling liquid level	3-10	C	C									
- Fuel level	3-10	C	C									
- Alternator/fan/crankshaft belt	3-10/20	R	C			R						
- Cyclonic pre-filter (OPTION)	3-11	N	N									
- Dry air filter cartridge	3-14/24	R		C/N			R					
- Radiator cores	3-14	N		N								
- Alternator/fan/crankshaft belt tension	3-18	C/A			C/A							
- Fuel pre-filter	3-18	N			N							
- Engine oil (2) (5)	3-20	V				V						
- Engine oil filter (2) (5)	3-20	R				R						
- Fuel filter	3-21	R				R						
- Fuel tank	3-24						N					
- Engine silent blocks							C (4)					
- Engine speeds							C (4)					
- Valve clearances		C					C (4)					
- Injectors								C/R (4)				
- Cooling liquid	3-26								V			
- Safety dry air filter cartridge	3-26								R			
- Radiator									C (4)			
- Water pump and the thermostat									C (4)			
- Alternator and the starter motor									C (4)			
- Injection pump										C (4)		
- Injection pressure										C (4)		
<b>TRANSMISSION</b>												
- Hydrostatic transmission circuit pressures										C (4)		
- Governing start of the hydrostatic transmission										C (4)		
- Hydrostatic transmission cut-off										C (4)		
<b>TIRES</b>												
- Tire pressures	3-14	C		C								
- Wheel nut tightening	3-14	C		C								
- Wheel nut tightening torques	3-27	C								C		
- Wheel	3-28											R
<b>BOOM</b>												
- Boom pads	3-11		N/G (3)									
- Boom	3-15	G		G								
- Boom pad wear							C (4)					
- Condition of boom assembly		C								C (4)		
- Bearings and articulation rings										C (4)		
<b>HYDRAULIC SYSTEM</b>												
- Hydraulic oil level	3-16	C		C								
- Hydraulic oil	3-21/27					C				V		
- Hydraulic return oil filter cartridge	3-22	R				R						
- Brake accumulator unit filter	3-27									R		
- Hydraulic pump tubular filter										N (4)		
- Condition of hoses and flexible pipes										C (4)		
- Condition of cylinders (leakage, shafts)										C (4)		
- Hydraulic circuit pressures										C (4)		

647511 (09/09/2016)  
MT 625 H EASY 49 K33A S1

A = ADJUST, C = CHECK, G = GREASE, N = CLEAN, P = BLEED, R = REPLACE, V = DRAIN	PAGE	(1)	DAILY OR EVERY 10 HOURS OF SERVICE	EVERY 50 HOURS OF SERVICE	EVERY 250 HOURS OF SERVICE	EVERY 500 HOURS OF SERVICE OR EVERY YEAR	EVERY 1000 HOURS OF SERVICE OR EVERY TWO YEARS	EVERY 1500 HOURS OF SERVICE OR EVERY TWO YEARS	EVERY 2000 HOURS OF SERVICE OR EVERY TWO YEARS	EVERY 3000 HOURS OF SERVICE	EVERY 4000 HOURS OF SERVICE	OCCASIONAL
<b>BRAKE</b>												
- Brake oil level	3-16	C		C								
- Brake oil							V (4)					
- Brake system							P (4)					
- Brake system pressure							C (4)					
- Brake							A (4)					
<b>STEERING</b>												
- Steering									C (4)			
- Steering swivel joints											C (4)	
<b>CAB</b>												
- Windscreen washer liquid level	3-16	C		C								
- Cab fan filter	3-17/18	R		N	R							
- Seat belt	3-25						C					
- Condition of the rear view mirrors							C (4)					
- Structure							C (4)					
<b>ELECTRICITY</b>												
- Longitudinal stability limiter and warning device	3-12/29	C	C									X
- Condition of wiring harness and cables							C (4)					
- Lights and signals							C (4)					
- Warning indicators							C (4)					
- Front headlights	3-30											A
- Battery failure	3-30											R
<b>FRONT AXLE</b>												
- Front wheel reducing gear pivots	3-15	G		G								G/C (4)
- Transfer box oil level	3-19				C							
- Front axle differential oil level	3-19				C							
- Front wheel reduction gear oil level	3-19				C							
- Transfer box oil	3-22	V				V						
- Front axle differential oil	3-23	V				V						
- Front wheel reduction gear oil	3-25	V					V					
- Wear of front axle brake discs												C (4)
- Front wheel reduction gear universal joint												C (4)
- Front wheel reduction gear clearance												C (4)
- Set of transfer box rolling bearings												C (4)
<b>REAR AXLE</b>												
- Rear wheel reducing gear pivots	3-15	G		G								G/C (4)
- Rear axle oscillation	3-15	G		G					G/C (4)			
- Rear axle differential oil level	3-19				C							
- Rear wheel reduction gear oil level	3-19				C							
- Rear axle differential oil	3-25	V					V					
- Rear wheel reduction gear oil	3-25	V					V					
- Wearing of rear axle brake discs												C (4)
- Rear wheel reduction gear universal joint												C (4)
- Rear wheel reduction gear clearance												C (4)
<b>CHASSIS</b>												
- Structure							C (4)					
- Bearings and articulation rings									C (4)			
<b>ATTACHMENTS</b>												
- Fork wear		C				C (4)						
- Attachment carriage							C (4)					
- Condition of attachments							C (4)					
<b>LIFT TRUCK</b>												
- Towing the lift truck	3-31											X
- Slings the lift truck	3-31											X
- Transporting the lift truck on a platform	3-32											X

647511 (09/09/2016)  
MT 625 H E6SY 49 K53A 51

## A - DAILY OR EVERY 10 HOURS OF SERVICE

### A1 – ENGINE OIL LEVEL

CHECK

Place the lift truck on level ground with the engine stopped, and let the oil settle in the sump.

- Open the engine bonnet.
- Pull out dipstick 1.
- Clean the dipstick and check the correct level between the two notches.
- If necessary, add oil (see: 3 - MAINTENANCE: LUBRICANTS AND FUEL) through the filler port 2.
- Visually check that there is no leakage or seepage of oil in the engine.

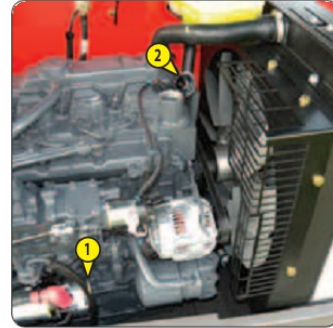

### A2 – COOLING LIQUID LEVEL

CHECK

Place the lift truck on level ground with the engine stopped, and allow the engine to cool.

#### ⚠ IMPORTANT ⚠

*To avoid any risk of spraying or burning, wait until the engine has cooled down before removing the cooling circuit filler plug.*

*If the cooling liquid is very hot, add only hot cooling liquid (80 °C).*

*In an emergency, you can use water as a cooling liquid, then change the cooling circuit liquid as soon as possible (see: 3 - MAINTENANCE: F1 - COOLING LIQUID).*

- Open the engine bonnet.
- The liquid must be at mid-height of the expansion tank 1.
- If necessary, add cooling liquid (see: 3 - MAINTENANCE: LUBRICANTS AND FUEL) through the filler port 2.
- Visually check that there is no leakage in the radiator and pipes.

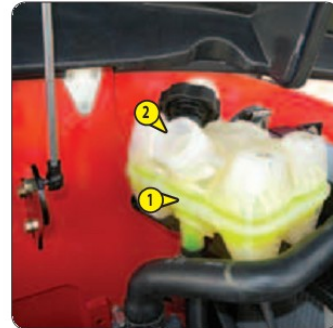

### A3 – FUEL LEVEL

CHECK

As far as possible, keep the fuel tank well filled in order to minimize condensation due to the atmospheric conditions.

#### ⚠ IMPORTANT ⚠

*Never smoke or approach with a flame during filling operations or when the tank is open.*

*Never refill while engine is running.*

- Check the fuel gage on the instrument panel.
- If necessary, add diesel (see: 3 - MAINTENANCE: LUBRICANTS AND FUEL).
- Open the fuel filler access panel with the ignition key.
- Remove cap 1.
- Fill the fuel tank with clean diesel filtered through the filler port 2.
- Refit the cap.
- Visually check that there is no leakage in the tank and pipes.

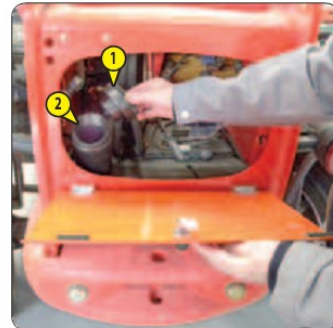

### A4 – ALTERNATOR/FAN/CRANKSHAFT BELT

CHECK

- Open the engine bonnet.
- Check the belt for signs of wear and cracks and change if necessary (see: 3 - MAINTENANCE: FILTERS CARTRIDGES AND BELTS).

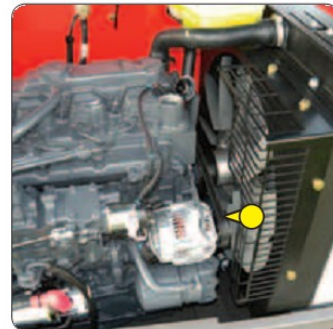

## A5 – CYCLONIC PRE-FILTER (OPTION)

CLEAN

The cleaning interval is given as a guide, however the pre-filter must be emptied and cleaned as soon as impurities reach the MAX level on the tank.

### ⚠ IMPORTANT ⚠

*When cleaning, take care not to let impurities into the dry air filter.*

- Loosen nut 1 remove cover 2 and empty the tank.
- Clean the pre-filter unit with a clean dry cloth and reassemble the unit.



## A6 – BOOM PADS

CLEAN - GREASE

To be carried out every 10 hours during the first 50 hours service, then once at 250 hours.

### ⚠ IMPORTANT ⚠

*If the lift truck is used in an abrasive environment (dust, sand, and coal.), use lubricating varnish (MANITOU reference: 483536). In this respect, consult your dealer.*

- Fully extend the boom.
- Apply the grease with a brush (see: 3 - MAINTENANCE: LUBRICANTS AND FUEL) to the 4 sides of the telescope(s).
- Telescope the boom several times in order to spread the coat of grease evenly.
- Remove the surplus of grease.















**⚠ IMPORTANT ⚠**

Use the test button  only when requested to do so, applying short presses (less than 1 second) and long presses (5 seconds) as instructed.

If in doubt during the test procedure, exit cleanly by short pressing the "BUCKET"  or "SUSPENDED LOAD"  MODE buttons.

These tests are essential for checking correct operation and adjustment of the various system components.

- Place the lift truck on flat, level ground with the wheels straight.
- Hold down the test button. 

<p><b>STEP 1</b> ↓</p>	 <ul style="list-style-type: none"> <li>- A beep.</li> <li>- First green LED flashing.</li> <li>- Test button lit.</li> </ul>	<p>→</p>  <ul style="list-style-type: none"> <li>- Place the lift truck with no attachment, with the boom fully retracted and raised.</li> </ul>	<p>→</p> <p>Short press the test button. </p> <p>→</p>	<p><b>TEST OK</b></p> <ul style="list-style-type: none"> <li>- Beeps once and progresses to stage 2.</li> </ul> <p><b>TEST NOT OK</b></p> <ul style="list-style-type: none"> <li>- Beeps twice fault indicator lamp comes on.</li> <li>- Exit test mode.</li> <li>- Go to stage 4.</li> </ul>
<p><b>STEP 2</b> ↓</p>	 <ul style="list-style-type: none"> <li>- First green LED continuously lit.</li> <li>- Second green LED flashing.</li> <li>- Test button lit.</li> </ul>	<p>→</p>  <ul style="list-style-type: none"> <li>- Lower with the engine running at full revs and the hydraulic control at the maximum setting. Slow the rate of descent until movement is cut-off.</li> </ul>	<p>→</p> <p>Short press the test button. </p> <p>→</p>	<p><b>TEST OK</b></p> <ul style="list-style-type: none"> <li>- Beeps once and progresses to stage 3.</li> </ul> <p><b>TEST NOT OK</b></p> <ul style="list-style-type: none"> <li>- Beeps twice fault indicator lamp comes on.</li> <li>- Exit test mode.</li> <li>- Go to stage 4.</li> </ul>
<p><b>STEP 3</b> ↓</p>	 <ul style="list-style-type: none"> <li>- First and second green LEDs continuously lit.</li> <li>- Third green LED flashing.</li> <li>- Test button lit.</li> </ul>	<p>→</p> <ul style="list-style-type: none"> <li>- Lower the boom until the movement is cut off.</li> <li>- Request, in the following order: a reverse tilt, a forward tilt (dumping) and a telescope extension. None of these 3 movements should be possible.</li> </ul>	<p>→</p> <p>Short press the test button. </p> <p>→</p>	<p><b>TEST OK</b></p> <ul style="list-style-type: none"> <li>- Conformity of aggravating movement cut-off.</li> <li>- Exit test mode. All the LEDs will light for 2 seconds and a beep will be sounded.</li> </ul> <p><b>TEST NOT OK</b></p> <ul style="list-style-type: none"> <li>- Fault indicator lamp  comes on.</li> <li>- Exit test mode.</li> <li>- Go to stage 4.</li> </ul>
<p><b>STEP 4</b></p>	 <ul style="list-style-type: none"> <li>- The fault indicator goes out.</li> </ul>	<p>→</p> <ul style="list-style-type: none"> <li>- Appearance of the pictogram  on the hour meter screen  together with the sounding of an audible beep</li> <li>- Scroll through the error codes (see: 2 - DESCRIPTION: 6B - SCREEN DISPLAYS: ERROR CODES).</li> <li>- If the error code "520393", the problem may be resolved by resetting the longitudinal stability limiter and warning device (see: 3 - MAINTENANCE: G - OCCASIONAL MAINTENANCE). Otherwise consult your dealer and provide the error code numbers.</li> </ul> <p>NOTE: For the stage 3 test, specify the non-conforming aggravating hydraulic movements, if necessary.</p>		

## B - EVERY 50 HOURS OF SERVICE

Carry out the operations described previously as well as the following operations.

### B1 – DRY AIR FILTER CARTRIDGE

CHECK - CLEAN

In case of use in a heavily dust laden atmosphere, there are pre-filtration cartridges (see: 3 - MAINTENANCE: FILTERS CARTRIDGES AND BELTS). Also, the checking and cleaning periodicity of the cartridge must be reduced.

#### ⚠ IMPORTANT ⚠

*If the clogging indicator light comes on, this operation must be carried out as quickly as possible (1 hour maximum). The cartridge must not be cleaned more than seven times, after which it must be changed. Never use the lift truck without an air filter or with a damaged air filter.*

*Respect the safety distance of 30 mm between the air jet and the cartridge to avoid tearing or making a hole in the cartridge. The cartridge must not be blown anywhere near the air filter box. Never clean the cartridge by tapping it against a hard surface. Your eyes must be protected during this intervention.*

*Never clean the dry air filter cartridge by washing it in liquid. Do not clean by any means the safety cartridge located inside the filter cartridge, change it for a new one if it is clogged or damaged*

- For the disassembly and reassembly of the cartridge, see: 3 - MAINTENANCE: D3 - DRY AIR FILTER CARTRIDGE.
- Clean the filter cartridge using a compressed air jet (max. pressure 3 bar) directed from the top to the bottom and from the inside towards the outside at a minimum distance of 30 mm from the cartridge wall.
- Cleaning is completed when there is no more dust on the cartridge.
- Clean the cartridge seal surfaces with a damp, clean lint-free cloth and grease with a silicone lubricant (MANITOU reference: 479292).
- Check visually the outer condition of the air filter and its mounts. Verify the condition of the hoses and their mounts also.

### B2 – RADIATOR CORES

CLEAN

#### ⚠ IMPORTANT ⚠

*In a polluting atmosphere, clean the radiator cores every day. Do not use a water jet or high-pressure steam as this could damage the radiator fins.*

- Open the engine bonnet.
- If necessary, clean the intake grille on the engine hood.
- Using a soft cloth, clean the radiator cores in order to remove as much dirt as possible.
- Clean the radiator using a compressed air jet aimed from the engine towards the radiator, in the opposite direction to the cooling air flow.



### B3 – TIRE PRESSURES AND WHEEL NUT TORQUES

CHECK

#### ⚠ IMPORTANT ⚠

*Check that the air hose is correctly connected to the tire valve before inflating and keep all persons at a distance during inflation. Follow the recommended tire pressures.*

- Check the condition of the tires, to detect cuts, blisters, wear, etc.
- Check the torque load of the wheel nuts. Non-compliance with this instruction can cause damage and rupture to the wheel bolts and distortion to the wheels.
- Check and restore tire pressures if necessary (see: 2 - DESCRIPTION: TIRES).

NOTE: There is an OPTIONAL wheel toolkit and anti-puncture kit.

To be carried out weekly, if the lift truck has been operated for less than 50 hours during the week.

**⚠ IMPORTANT ⚠**

*In the event of prolonged use in an extremely dusty or oxidizing atmosphere, reduce this interval to every 10 hours of service or every day.*

Clean and lubricate the following points with grease (see: 3 - MAINTENANCE: LUBRICANTS AND FUEL) and remove the surplus of grease.

**BOOM**

- 1 - Lubricators of the boom axle (2 lubricators).
- 2 - Lubricator of the carriage axle (1 lubricator).
- 3 - Lubricator of the tilt cylinder foot axle (1 lubricator).
- 4 - Lubricator of the tilt cylinder head axle (1 lubricator).
- 5 - Lubricator of the lifting cylinder foot axle (1 lubricator).
- 6 - Lubricator of the lifting cylinder head axle (1 lubricator).
- 7 - Lubricator of the compensation cylinder foot axle (1 lubricator).
- 8 - Lubricator of the compensation cylinder head axle (1 lubricator).

**FRONT AND REAR WHEEL REDUCTION GEAR PIVOTS**

- 9 - Lubricators of the wheel reduction gear pivot pins (8 lubricators).

**REAR AXLE OSCILLATION**

- 10 - Rear axle oscillation lubricators (2 lubricators).



## B5 – HYDRAULIC OIL LEVEL

CHECK

If necessary, remove and reconnect the hydraulic attachment (see: 4 - OPTIONAL ATTACHMENTS FOR USE WITH THE RANGE: PICKING UP THE ATTACHMENTS). Place the lift truck on level ground with the engine stopped and the boom retracted and lowered to its maximum extent.

### ⚠ IMPORTANT ⚠

*Use a clean funnel and clean the underside of the oil drum before filling.*

- Check dipstick 1, the correct level must stand at the level of the red point.
- If necessary, add oil (see: 3 - MAINTENANCE: LUBRICANTS AND FUEL).
- Remove cap 2.
- Add oil through filler port 3.
- Refit the cap.
- Visually check that there is no leakage in the tank and pipes.



## B6 – BRAKE OIL LEVEL

CHECK

Place the lift truck on level ground.

### ⚠ IMPORTANT ⚠

*If the oil level is abnormally low, consult your dealer.*

- Remove protective casing 1 using key 2.
- Check tank 3. The correct level must stand at the MAX level in the tank.
- If necessary, add oil (see: 3 - MAINTENANCE: LUBRICANTS AND FUEL).
- Remove cap 4.
- Add oil through filler port 5.
- Put the cap back 4.
- Check visually that there is no leakage in the tank and pipes.

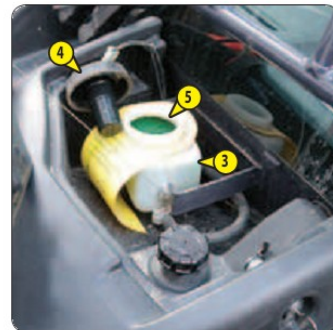
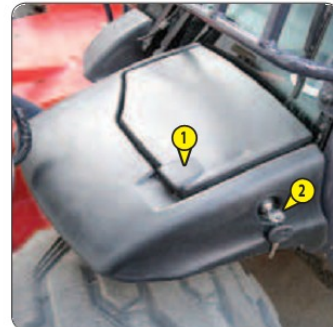

## B7 – WINDSCREEN WASHER LIQUID LEVEL

CHECK

- Remove cap 1.
- Visually check the level in tank 2.
- If necessary add windscreen washer liquid (see: 3 - MAINTENANCE: LUBRICANTS AND FUEL) through filler port 3.
- Put the cap back.



647511 (09/09/2016)  
MT 625 H E6SY 49 K5B3A 51



## **B8 – CAB VENTILATION FILTER**

**CLEAN**

- Remove the protective grid 1.
- Lift out cab ventilation filter 2.
- Clean the filter with a compressed air jet.
- Check its condition and change if necessary (see: 3 - MAINTENANCE: FILTERS CARTRIDGES AND BELTS).
- Reinstall the filter.
- Refit the protective grid 1.



## C - EVERY 250 HOURS OF SERVICE

Carry out the operations described previously as well as the following operations.

### C1 – ALTERNATOR/FAN/CRANKSHAFT BELT TENSION

CHECK - ADJUST

#### ⚠ IMPORTANT ⚠

*If the compressor belt has to be changed, check the tension again after the first 20 hours of operation.*

- Open the engine bonnet.
- Check the belt for signs of wear and cracks and change if necessary (see: 3 - MAINTENANCE: FILTERS CARTRIDGES AND BELTS).
- Check the belt tension between the pulleys of the crankshaft and of the alternator.
- Under a normal pressure exerted with the thumb (45 N), the belt should move approximately 10 mm.
- Adjust if necessary.
- Loosen screws 1 by two to three turns.
- Swivel the alternator assembly so as to obtain the required belt tension.
- Re-tighten screws 1 (tightening torque 22 N.m).

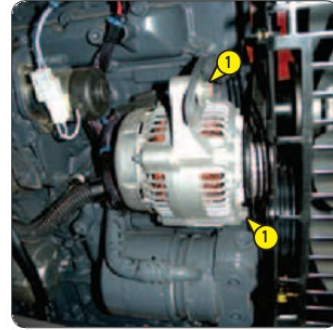

### C2 – FUEL PRE-FILTER

CLEAN

#### ⚠ IMPORTANT ⚠

*Carefully clean the outside of the pre-filter and its holder, to prevent dust from getting into the system.*

- Open the engine bonnet.
- Close the fuel valve 1 by setting to position B.
- Unscrew the retaining ring 2, remove the housing 3 and clean the inside using a brush immersed in clean diesel oil.
- Remove the cartridge filter and dip in diesel oil to rinse.
- Reassemble the unit.
- Open the fuel valve 1 by setting to position A.

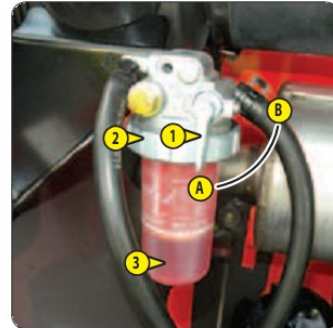

### C3 – CAB VENTILATION FILTER

REPLACE

- Remove the protective grid 1.
- Lift out cab ventilation filter 1 and replace it with a new one (see: 3 - MAINTENANCE: FILTERS, CARTRIDGES AND BELTS).
- Refit the protective grid 1.



#### **C4 - TRANSFER BOX OIL LEVEL**

**CHECK**

Place the lift truck on level ground with the engine stopped.

- Remove access panel 1.
- Remove the level plug 2, the oil should be flush with the edge of the hole.
- If necessary, add oil (see: 3 - MAINTENANCE: LUBRICANTS AND FUEL) by the same hole.
- Refit and tighten the level plug 2 (tightening torque 34 to 49 N.m).
- Refit access panel 1.

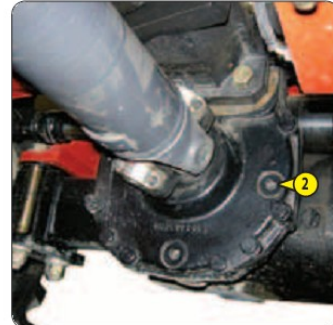

#### **C5 - FRONT AXLE DIFFERENTIAL OIL LEVEL**

**CHECK**

Place the lift truck on level ground with the engine stopped.

- Remove the level plug 1, the oil should be flush with the edge of the hole.
- If necessary, add oil (see: 3 - MAINTENANCE: LUBRICANTS AND FUEL) via the same hole.
- Refit and tighten the level plug 1 (tightening torque 34 to 49 N.m).



#### **C6 - REAR AXLE DIFFERENTIAL OIL LEVEL**

**CHECK**

Place the lift truck on level ground with the engine stopped.

- Remove the level plug 1, the oil should be flush with the edge of the hole.
- If necessary, add oil (see: 3 - MAINTENANCE: LUBRICANTS AND FUEL) via the same hole.
- Refit and tighten the level plug 1 (tightening torque 34 to 49 N.m).

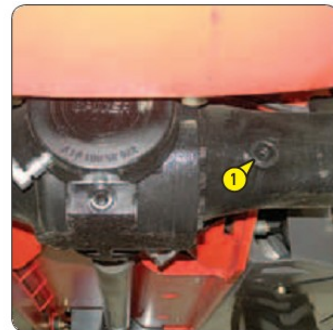

#### **C7 - FRONT AND REAR WHEEL REDUCTION GEAR OIL LEVEL**

**CHECK**

Place the lift truck on level ground with the engine stopped.

- Check the level on each wheel reduction gear.
- Place level plug 1 in a horizontal position.
- Remove the level plug; the oil should be flush with the edge of the opening.
- If necessary, add oil (see: 3 - MAINTENANCE: LUBRICANTS AND FUEL) via the same hole.
- Refit and tighten the level plug (tightening torque 34 to 49 N.m).

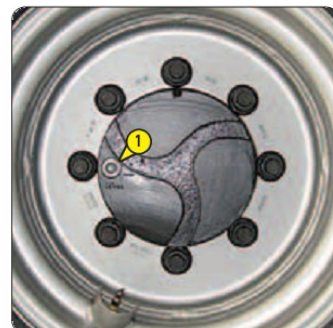

647511 (09/09/2016)  
MT 625 H E6SY 49 K53A 51

## D - EVERY 500 HOURS OF SERVICE OR EVERY YEAR

Carry out the operations described previously as well as the following operations.

### D1 - ENGINE OIL

DRAIN

### D2 - ENGINE OIL FILTER

REPLACE

Place the lift truck on level ground, let the engine run at idle for a few minutes, then stop the engine.

#### **⚠ IMPORTANT ⚠**

*Dispose of the waste oil in an ecological manner.  
Hand-tighten the oil filter and lock in place with a quarter turn.*

#### DRAINING THE OIL

- Open the engine bonnet.
- Remove access panel 1.
- Place a container under the drain port and unscrew the drain plug 2.
- Remove the filling plug 3 to ensure that the oil is drained properly.

#### REPLACEMENT OF THE FILTER

- Unscrew and discard the engine oil filter 4, together with its seal.
- Clean the filter bracket with a clean, lint-free cloth.
- Lightly grease the new seal before refitting the new oil filter (see: 3 - MAINTENANCE: FILTERS, CARTRIDGES AND BELTS) on its bracket.

#### FILLING UP THE OIL

- Refit and tighten the drain plug 1.
- Fill up with oil (see: 3 - MAINTENANCE: LUBRICANTS AND FUEL) through filler port 5.
- Wait a few minutes to allow the oil to flow into the sump.
- Start the engine and let it run for a few minutes.
- Check for possible leaks from the drain plug and the oil filter.
- Stop the engine, wait a few minutes and check the correct level between the two level marks on the dipstick 6.
- Top up the level if necessary.
- Refit access panel 1.

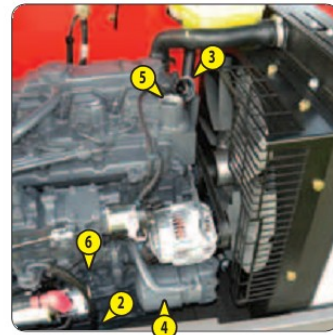

### D3 - ALTERNATOR/FAN/CRANKSHAFT BELT

REPLACE

#### **⚠ IMPORTANT ⚠**

*If the alternator belt has to be changed, check the tension again after the first 20 hours of operation.*

- Open the engine bonnet.
- Undo screws 1 and remove radiator protection grill 2.
- Loosen screws 3 by two to three turns.
- Swivel the alternator assembly so as to free belt 4.
- Pass belt 4 behind radiator propeller 5 to remove it and replace with a new one (see: 3 - MAINTENANCE: FILTERS CARTRIDGES AND BELTS).
- Adjust the belt tension between the crankshaft and alternator pulleys.
- Under pressure applied by the thumb (98 N), the tension should be between 7 and 9 mm.
- Swivel the alternator assembly so as to obtain the belt tension required.
- Retighten screws 1 (tightening torque 22 N.m).
- Refit the radiator protection grill 2.

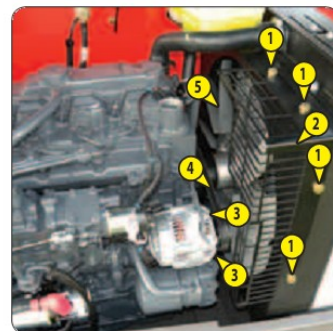

## D4 – FUEL FILTER

REPLACE

### ⚠ IMPORTANT ⚠

*Carefully clean the outside of the filter and its holder, to prevent dust from getting into the system.*

*Tighten the fuel filter by hand only and lock the filter in place by a quarter turn.*

- Open the engine bonnet.
- Unscrew and discard the fuel filter 1.
- Clean the inside of the filter head using a brush immersed in clean diesel oil.
- Refit a filter and a new seal lubricated with clean diesel beforehand (see: 3 - MAINTENANCE: FILTERS CARTRIDGES AND BELTS).
- Open the bleed screw 2 of the fuel filter.
- Operate the starter and close the bleed screw as soon as the diesel flows with no air.

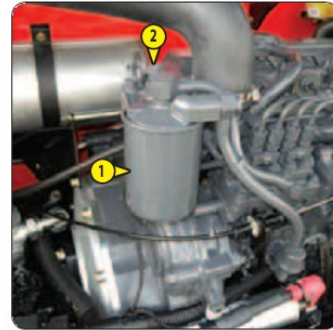

## D5 – HYDRAULIC OIL

CHECK

MANITOU recommends analyzing the hydraulic oil after the first 500 hours of lift truck operation. Following that, MANITOU requires the oil to be analyzed every 500 hours of operation. The results will dictate whether or not the hydraulic oil is changed (contact your dealer).

MANITOU oil analysis kit Part No. 958162.



## D6 – HYDRAULIC RETURN OIL FILTER CARTRIDGE

REPLACE

Stop the engine and release the pressure from the systems by operating the hydraulic control.

### ⚠ IMPORTANT ⚠

*Raise the boom and place the boom safety wedge on the rod of the lifting cylinder (see: 1 - OPERATING AND SAFETY INSTRUCTIONS: LIFT TRUCK MAINTENANCE INSTRUCTIONS).*

### ⚠ IMPORTANT ⚠

*Thoroughly clean the outside of the filter and its surroundings before any operation to prevent any risk of polluting the hydraulic system.*

- Remove cap 1.
- Place a container under hydraulic return oil filter.
- Unscrew the cover 2.
- Wait a few seconds for the oil to flow into the container.
- Slowly take out filter cartridge assembly 3 and 4.
- Separate the head 3 from the filter cartridge 4 with a twisting motion.
- Refit the head onto a new cartridge (see: 3 - MAINTENANCE: FILTERS CARTRIDGES AND BELTS).
- Fit the assembly in place and re-tighten cover 2.
- Put the cap 1 back.

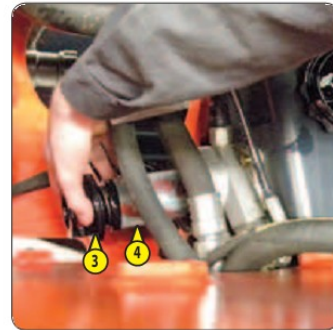
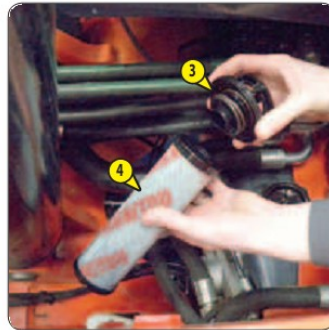

## D7 – TRANSFER BOX OIL

DRAIN

Place the lift truck on level ground with the engine stopped and the transfer box oil still warm.

### ⚠ IMPORTANT ⚠

*Dispose of the drain oil in an ecological manner.*

- Remove access panel 1.
- Place a container under drain plug 2 and unscrew the plug.
- Remove level and filling plug 3 to ensure proper emptying.
- Refit and tighten the drain plug 2 (tightening torque 34 to 49 N.m).
- Fill up with oil (see: 3 - MAINTENANCE: LUBRICANTS AND FUEL) through filler port 3.
- The level is correct when the oil level is flush with the edge of the hole.
- Check for any possible leaks at the drain plug.
- Refit and tighten the filler port plug 3 (tightening torque 34 to 49 N.m).
- Refit access panel 1.

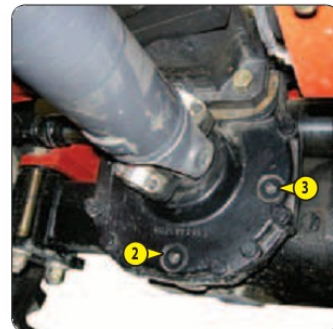

## D8 – FRONT AXLE DIFFERENTIAL OIL

### DRAIN

Place the lift truck on level ground with the engine stopped and the still warm differential oil.

#### **⚠ IMPORTANT ⚠**

*Dispose of the drain oil in an ecological manner.*

- Place a container under the drain plug 1 and unscrew the plug.
- Remove level and filling plug 2 to ensure proper emptying.
- Refit and tighten the drain plug 1 (tightening torque 34 to 49 N.m).
- Fill up with oil (see: 3 - MAINTENANCE: LUBRICANTS AND FUEL) through filler port 2.
- The level is correct when the oil level is flush with the edge of the hole.
- Check for any possible leaks at the drain plug.
- Refit and tighten the filler port plug 3 (tightening torque 34 to 49 N.m).



## E - EVERY 1000 HOURS OF SERVICE OR EVERY TWO YEARS

Carry out the operations described previously as well as the following operations.

### E1 – FUEL TANK

CLEAN

Place the lift truck on level ground with the engine stopped.

#### ⚠ IMPORTANT ⚠

*Do not smoke or approach with a flame during this operation.*

*Never attempt to carry out welding or any other operation by yourself, as this could cause an explosion or a fire.*

- Inspect the parts susceptible to leaks in the fuel circuit and in the tank both visually and by touch.
- In the event of a leak, contact your dealer.
- Place a container under drain plug 1 and unscrew the plug.
- Open the fuel filler access panel 2 with the ignition key.
- Remove the filling plug 3 to ensure that the oil is drained properly.
- Rinse out with ten liters of clean diesel through filler port 4.
- Refit and tighten the drain plug 1 (tightening torque 29 to 39 N.m).
- Fill the fuel tank with clean diesel filtered through the filler port.
- Refit the filler plug.
- Close access panel 2.

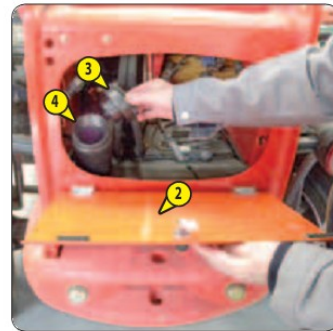

### D2 – DRY AIR FILTER CARTRIDGE

REPLACE

In case of use in a heavily dust laden atmosphere, there are pre-filtration cartridges, see: 3 - MAINTENANCE: FILTERS CARTRIDGES AND BELTS. Also, the checking and cleaning periodicity of the cartridge must be reduced (up to 250 hours in a heavily laden dust atmosphere and with pre-filtration).

#### ⚠ IMPORTANT ⚠

*Change the cartridge in a clean location, with the engine stopped. Never operate the lift truck with the air filter removed or damaged.*

- Loosen the bolts and remove cover 1.
- Gently remove the cartridge 2 taking care to avoid spilling the dust.
- Leave the safety cartridge in place.
- The following parts must be cleaned with a damp, clean lint-free cloth.
  - The inside of the filter and cover.
  - The inside of the filter inlet hose.
  - The gasket surfaces in the filter and in the cover.
- Check pipes and connections between the air filter and the engine and the connection and state of the clogging indicator on the filter.
- Before mounting check the condition of the new cartridge (see: 3 - MAINTENANCE: FILTERS CARTRIDGES AND BELTS).
- Insert the cartridge in the filter axis and push it home, pressing against the outer edge and not the center.
- Reassemble the cover, guiding the valve downwards.





**⚠ IMPORTANT ⚠**

*In no event should the lift truck be used if the seat belt is defective (fixing, locking, cuts, tears, etc.).  
Repair or replace the seat belt immediately.*

## SEAT BELT WITH TWO ANCHORING POINTS

- Check the following points:
  - Fixing of the anchoring points on the seat.
  - Cleanness of the strap and the locking mechanism.
  - Triggering of the locking mechanism.
  - Condition of the strap (cuts, curled edges).

## REELED SEAT BELT WITH TWO ANCHORING POINTS

- Check the points listed above together with the following points:
  - The correct winding of the belt.
  - Condition of the reel guards.
  - Roller locking mechanism when the strap is given a sharp tug.

NOTE: After an accident, replace the seat belt.

**E4 – REAR AXLE DIFFERENTIAL OIL****DRAIN**

Place the lift truck on level ground with the engine stopped and the differential oil still warm.

**⚠ IMPORTANT ⚠**

*Dispose of the drain oil in an ecological manner.*

- Place a container under drain plug 1 and unscrew the plug.
- Remove level and filling plug 2 to ensure proper emptying.
- Refit and tighten the drain plug 1 (tightening torque 34 to 49 N.m).
- Fill up with oil (see: 3 - MAINTENANCE: LUBRICANTS AND FUEL) through filler port 2.
- The level is correct when the oil level is flush with the edge of the hole.
- Check for any possible leaks at the drain plug.
- Refit and tighten the filler port plug 2 (tightening torque 34 to 49 N.m).

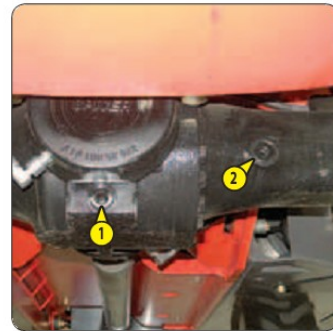
**E5 – FRONT AND REAR WHEEL REDUCTION GEAR OIL****DRAIN**

Place the lift truck on level ground with the engine stopped and the reduction gear oil still warm.

**⚠ IMPORTANT ⚠**

*Dispose of the drain oil in an ecological manner.*

- Drain and change the oil of each wheel reduction gear.
- Place drain plug 1 in position A.
- Place a container under the drain plug and unscrew the plug.
- Let the oil drain fully.
- Place the drain port in position B, i.e. in a level port.
- Fill up with oil (see: 3 - MAINTENANCE: LUBRICANTS AND FUEL) through level port 1.
- The level is correct when the oil level is flush with the edge of the hole.
- Refit and tighten the drain plug (tightening torque 34 to 49 N.m).

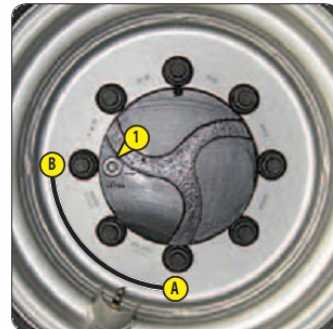

## F - EVERY 2000 HOURS OF SERVICE OR EVERY TWO YEARS

Carry out the operations described previously as well as the following operations.

### F1 - COOLING LIQUID

#### DRAIN

These operations are to be carried out when needed or once every two years at the beginning of winter. Place the lift truck on level ground with the engine stopped and cold.

#### ⚠ IMPORTANT ⚠

*The engine does not contain any corrosion resistor and must be filled throughout the whole of the year with a mixture containing 25 % of ethylene glycol-based antifreeze.*

#### DRAINING THE LIQUID

- Open the engine bonnet.
- Remove access panel 5.
- Place a container under the radiator drain plug 1 and unscrew the plug.
- Remove filler plug 2 from the expansion tank and fully open the heating control to ensure proper emptying.
- Let the cooling circuit drain entirely while ensuring that the ports do not get clogged.
- Check the condition of the hoses as well as the fastening devices and change the hoses if necessary.
- Rinse the circuit with clean water and use a cleaning agent if necessary.

#### FILLING THE LIQUID

- Refit and tighten the radiator drain plug 1 (tightening torque 20 N.m).
- Slowly fill the circuit with cooling liquid (see: 3 - MAINTENANCE: LUBRICANTS AND FUEL) up to the middle of the expansion tank 3, via filler port 4.
- Refit filler plug 2.
- Run the engine at idle for a few minutes.
- Check for any possible leaks.
- Check the level and refill if necessary.



### F2 - SAFETY DRY AIR FILTER CARTRIDGE

#### REPLACE

- For the disassembly and reassembly of the dry air filter cartridge, see: 3 - MAINTENANCE: D3 - AIR FILTER CARTRIDGE.
- Gently remove the dry air filter safety cartridge 1, taking care to avoid spilling the dust.
- Clean the gasket surface on the filter with a damp, clean lint-free cloth.
- Check the condition of the new safety cartridge before fitting (see: 3 - MAINTENANCE: FILTERS AND BELTS).
- Insert the cartridge in the filter axis and push it home, pressing against the outer edge and not the center.

NOTE: The safety cartridge replacement frequency is given for information only. It must be changed every second time the dry air filter cartridge is changed.

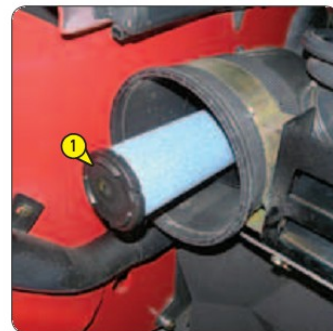

- Check the condition of the tires, to detect cuts, blisters, wear, etc.
- Check the tightening torque of the wheel nuts with a torque wrench.
  - Front tires: 630 N.m ± 15 %
  - Rear wheels: 630 N.m ± 15%

**F4 – HYDRAULIC OIL**

DRAIN

**F5 – BRAKE ACCUMULATOR UNIT FILTER**

REPLACE

Place the lift truck on level ground with the engine stopped.

**⚠ IMPORTANT ⚠**

*Raise the boom and place the boom safety wedge on the rod of the lifting cylinder (see: 1 - OPERATING AND SAFETY INSTRUCTIONS: LIFT TRUCK MAINTENANCE INSTRUCTIONS).*

**⚠ IMPORTANT ⚠**

*Before carrying out any work, thoroughly clean the area around the filter, the drain and filling plugs. Dispose of the drain oil in an ecological manner. Use a very clean container and funnel and clean the top of the oil drum before filling.*

**DRAINING THE OIL**

- Place a container under drain plugs 1 and unscrew them.
- Remove the filling plug 2 to ensure that the oil is drained properly.

**REPLACING THE BRAKE ACCUMULATOR UNIT FILTER**

- Remove the cover plate 3.
- Unscrew plug 4, lift out the filter and fit a new one (see: 3 - MAINTENANCE: FILTERS CARTRIDGES AND BELTS).
- Refit and tighten plug 4 (tightening torque 70 to 80 N.m).
- Refit cover plate 3.

**FILLING UP THE OIL**

- Clean and refit the drain plugs 1 (tightening torque 29 to 39 N.m).
- Fill up with oil (see: 3 - MAINTENANCE: LUBRICANTS AND FUEL) through filler port 5.
- Observe the oil level on dipstick 6, the oil level should be at the level of the red point.
- Check for any possible leaks at the drain plugs.
- Refit filler plug 2.

**HYDRAULIC CIRCUIT DECONTAMINATION**

- This should be carried out by your dealer after each oil change.
- The hydraulic oil used in the circuit must be at least equal in quality to class 8 (according to NAS 1638). Your dealer will be able to clean the hydraulic circuit using an external unit and check the quality of the oil in order to ensure the long life of hydraulic components and particularly of the main pump.

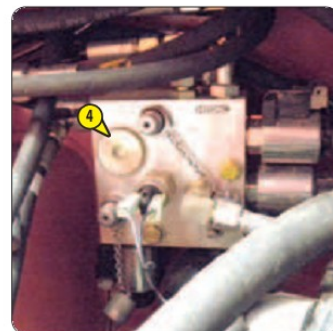
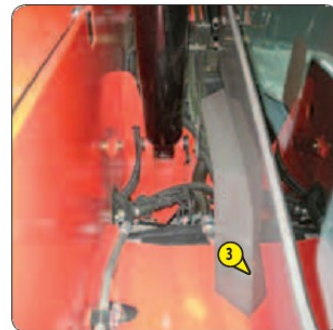
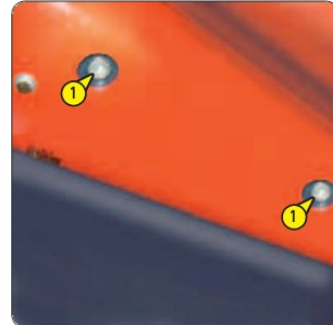

## G - OCCASIONAL MAINTENANCE

### G1 - WHEEL

#### REPLACE

For this operation, we advise you to use the MANITOU hydraulic jack, part no. 505507 and the MANITOU safety support, part no. 554772.

#### **⚠ IMPORTANT ⚠**

*In the event of a wheel being changed on the public highway, secure the lift truck vicinity:*

- Stop the lift truck, if possible on firm, level ground.
- Shut-down the lift truck (see: 1 - OPERATING AND SAFETY INSTRUCTIONS: DRIVING INSTRUCTIONS UNLADEN AND LADEN).
- Switch on the hazard warning lights.
- Immobilize the lift truck in both directions on the axle opposite to the wheel to be changed.
- Loosen the nuts of the wheel to be changed.
- Place the jack under the flared axle tube, as near as possible to the wheel and adjust the jack.
- Raise the wheel until it is clear of the ground and place the safety support under the axle.
- Completely unscrew the wheel nuts and remove them.
- Free the wheel by reciprocating movements and roll it to the side.
- Slip the new wheel on the wheel hub.
- Hand-tighten the nuts, grease them if necessary.
- Remove the safety support and lower the lift truck with the jack.
- Tighten the wheel nuts with a torque wrench (see: 3 - MAINTENANCE: A - DAILY OR EVERY 10 HOURS OF SERVICE for tightening torque).



According to the use of the lift truck, the device may require to be periodically reset.













This procedure allows this operation to be easily done.

- Provide a fork carrier or a bucket and a load corresponding to at least half the lift truck's rated capacity.
- Preferably perform the reset when the lift truck is still cold (before it is used) or ensure that the temperature of the rear axle is not more than 50 °C.
- Place the lift truck on flat, level ground with the wheels straight.

**⚠ IMPORTANT ⚠**

*Carefully follow the boom positioning instructions. Two audible beeps and lighting of the warning indicator lamp ⚠ will inform you if you have failed to follow these instructions correctly. If in doubt, contact your dealer.*

*When the reset is complete, check correct operation of the longitudinal stability limiter and warning device (see: 3 - MAINTENANCE: A - DAILY OR EVERY 10 HOURS OF SERVICE).*

<p><b>STEP 1</b> <b>START</b></p>	 <p>- Without attachments. - Boom fully retracted and raised.</p>	<p>Simultaneously press and hold down the "BUCKET" MODE  and TEST  buttons.</p> <p>- Two beeps will sound and all the LEDs will flash twice to confirm the start of the procedure.</p>
<p><b>STEP 2</b></p>	 <p>- A beep. - First green LED flashing. - Test button flashing.</p>	 <p>- Without attachments. - Carriage tilted fully backwards. - Boom fully retracted and in the down position a few centimeters off the ground.</p> <p>Short press the test button. </p>
<p><b>STEP 3</b></p>	 <p>- First green LED continuously lit. - Second green LED flashing. - Test button flashing.</p>	 <p>- With the fork carrier or the bucket and a load (keep boom retracted to allow all other hydraulic movements). - Boom fully retracted and in the down position a few centimeters off the ground.</p> <p><b>⚠ IMPORTANT ⚠</b></p> <p><i>Always keep the load as close to the ground as possible during this operation.</i></p> <p>- Hold down the disable the "aggravating" hydraulic movement cut-off button  (indicator lamp lit), and telescope the boom until the rear wheels leave the ground.</p> <p>NOTE: This stage consists in unloading the rear axle. It can be done using a jack but without bearing on the rear axle.</p> <p>Short press the test button. </p> <p>Two beeps will sound and all the LEDs will flash twice to confirm the end of the procedure.</p>
<p><b>STEP 4</b> <b>END</b></p>	 <p>- All LEDs lit. - A continuous audible beep.</p>	 <p>- After completing the resetting procedure, the lift truck is in an overloaded condition. Retract the telescope to restore the situation.</p>

### G3 – FRONT HEADLIGHTS

ADJUST

#### RECOMMENDED SETTING

(as per standard ECE-76/756 76/761 ECE20)

Set to -2% of the dipped beam in relation to the horizontal line of the headlamp.

#### ADJUSTMENT PROCEDURE

- Place the unladen lift truck in the transport position and perpendicular to a white wall on flat, level ground.
- Check the tire pressures (see: 2 - DESCRIPTION: FRONT AND REAR TYRES).
- Place the forward/reverse selector in neutral.

#### CALCULATING THE HEIGHT OF THE DIPPED BEAM (H2)

- h1 = Height of the dipped beam in relation to the ground.
- h2 = Height of the adjusted beam.
- l = Distance between the dipped beam and the white wall.

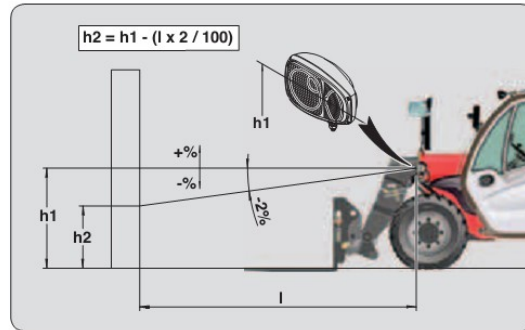

### G4 – BATTERY FAILURE

REPLACE

#### ⚠ IMPORTANT ⚠

*Operate the battery cut-off no less than 30 seconds after having switched off the ignition with the ignition key.*

*Handling and servicing a battery can be dangerous, take the following precautions:*

- Wear protective goggles.
  - Keep the battery horizontal.
  - Never smoke or work near a naked flame.
  - Work in a well-ventilated area.
- In the event of electrolyte being spilled onto the skin or splashed in the eyes, rinse thoroughly with cold water for 15 minutes and call a doctor.*

- Open the engine bonnet.
- Bring a backup battery of the same type as that of the lift truck, together with battery cables.
- Connect the backup battery according to the correct polarity with the (-) on the engine ground 1 and the (+) on the (+) of starter 2.
- Start the lift truck and remove the cables as soon as the engine is running.

#### ⚠ IMPORTANT ⚠

*Raise the boom and place the boom safety wedge on the rod of the lifting cylinder (see: 1 - OPERATING AND SAFETY INSTRUCTIONS: LIFT TRUCK MAINTENANCE INSTRUCTIONS).*

- Remove the protective casing 3.
- Change the battery 4.

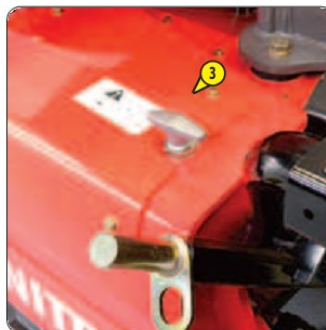
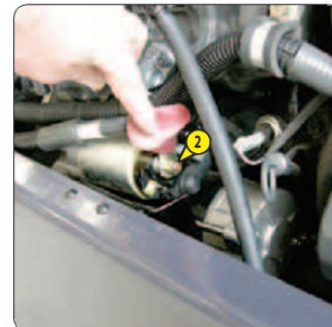
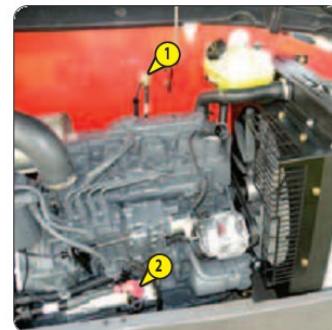

## G5 - LIFT TRUCK

### TOWING

#### ⚠ IMPORTANT ⚠

*If the lift truck is not on level ground, chock it so that it does not descend the slope.*

*The lift truck must be towed very slowly (less than 5 km/h) and for as short a distance as possible (less than 100 m).*

For towing a lift truck, the high pressure limiters must be unlocked to avoid damaging the hydrostatic transmission, and the parking brake on the front axle must be released.

- Switch on lift truck ignition.
- Set the forward/reverse selector to neutral.
- Release the hand brake.

#### UNLOCKING THE HIGH PRESSURE LIMITERS

- Open the engine bonnet.
- Loosen nuts 1 on the hydrostatic pump by no more than three turns.

#### RELEASING THE PARKING BRAKE ON THE FRONT AXLE

- Unscrew the screws 2 on the front axle, remove the shims 3 and fully re-tighten the screws 2.

#### TOWING

- Switch on the hazard warning lights.
- Since there will be no steering or braking hydraulic assistance, operate the steering and pedal slowly avoiding sudden or jerky movements.
- After towing, re-tighten nuts 1 (tightening torque 70 N.m).
- Unscrew the screws 2, refit the shims 3 and re-tighten the screws 2 (tightening torque 95 - 115 N.m).

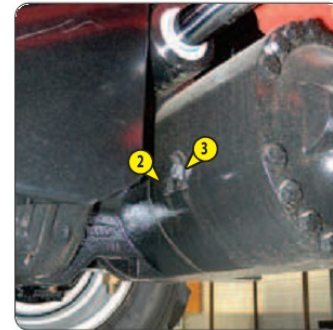
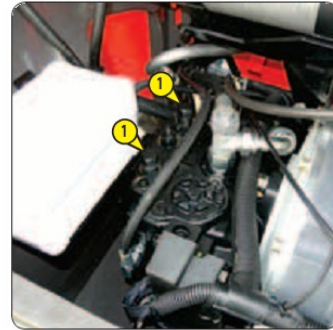

## G6 - LIFT TRUCK

### SLING

- Take into account the position of the lift truck center of gravity for lifting.

A = 1200 mm      B = 1100 mm

- Place the hooks in the fastening points 1 provided.

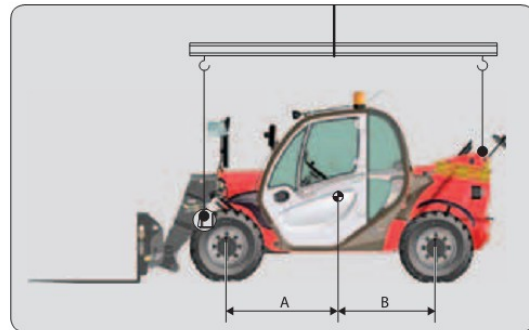

**⚠ IMPORTANT ⚠**

Ensure that the safety instructions associated with the platform are complied with before loading the lift truck and that the driver of the carrier vehicle is informed of the dimensions and the ground of the lift truck (see: 2-DESCRIPTION: CHARACTERISTICS).

Ensure that the platform is of sufficient size and load capacity for transporting the lift truck. Check also the allowable ground contact pressure of the platform relative to the lift truck.

**⚠ IMPORTANT ⚠**

For lift trucks equipped with a turbo-charged engine, block off the exhaust outlet to avoid rotation of the turbo shaft without lubrication when transporting the vehicle.

**LOADING THE LIFT TRUCK**

- Block the wheels of the platform.
- Attach the loading ramps to the platform in such a way as to give the shallowest possible ramp angle for the lift truck.
- Load the lift truck parallel to the platform.
- Shut down the lift truck (see: 1 - OPERATING AND SAFETY INSTRUCTIONS: DRIVING INSTRUCTIONS UNLADEN AND LADEN).

**STOWING THE LIFT TRUCK**

- Fix the chocks to the platform at the front and the rear of each tire.
- Also fix the chocks to the platform on the inside of each tire.
- Secure the lift truck to the platform with sufficiently strong ropes to the anchoring points 1 provided.
- Tighten the ropes.

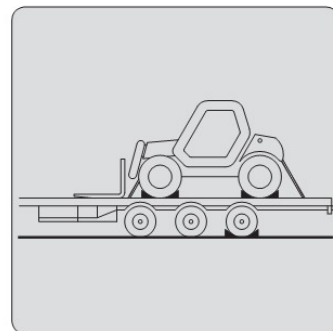
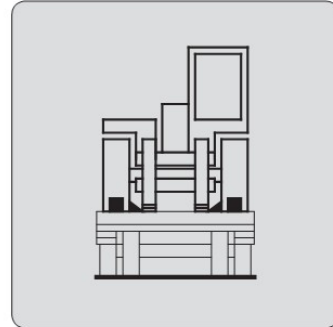
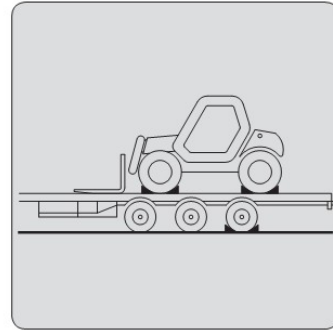

647511 (09/09/2016)  
MT 625 H E6SY 49 K53A 51



# ***4 - OPTIONAL ATTACHMENTS FOR USE WITH THE RANGE***

## TABLE OF CONTENTS

### 4 - OPTIONAL ATTACHMENTS FOR USE WITH THE RANGE

<u>INTRODUCTION</u>	<u>5</u>
<u>PICKING UP THE ATTACHMENTS</u>	<u>6</u>
<u>TECHNICAL SPECIFICATIONS OF ATTACHMENTS</u>	<u>8</u>
<u>ATTACHMENT SHIELDS</u>	<u>13</u>

## INTRODUCTION

- Your lift truck must be used with interchangeable equipment. These items are called: ATTACHMENTS.
- A wide range of attachments, specially designed and perfectly suitable for your lift truck is available and guaranteed by MANITOU.

### **⚠ IMPORTANT ⚠**

*Only attachments approved by MANITOU are to be used on our lift trucks*

*(see: 4 - ADAPTABLE ATTACHMENTS IN OPTION ON THE RANGE: TECHNICAL SPECIFICATIONS OF ATTACHMENTS).*

*The manufacturer's liability will be denied in case of modification or of attachment adaptation carried out without his knowing it.*

- The attachments are delivered with a load chart concerning your lift truck. The operator's manual and the load chart should be kept in the places provided in the lift truck. For standard attachments, their use is governed by the instructions contained on this notice.

### **⚠ IMPORTANT ⚠**

*Maximum loads are defined by the capacity of a lift truck taking account of the attachment's mass and centre of gravity.*

*In the event of the attachment having less capacity than the lift truck, never exceed this limit.*

- Some particular uses require the adaptation of the attachment which is not provided in the price-listed options. Optional solutions exist, consult your dealer.

### **⚠ IMPORTANT ⚠**

*Depending on their size, certain attachments may, when the boom is lowered and retracted, come into contact with the front tyres and cause damage to them, if reverse tilt is activated in the forward tilt direction.*

**TO REMOVE THIS RISK, EXTEND THE TELESCOPE TO A SUFFICIENT EXTENT FOR THE PARTICULAR LIFT TRUCK AND ATTACHMENT SO THAT THIS CONTACT IS NOT POSSIBLE.**

## SUSPENDED LOAD

### **⚠ IMPORTANT ⚠**

*Suspended load MUST be handled with a lift truck designed for that purpose*

*(see: 1 - OPERATING AND SAFETY INSTRUCTIONS: LOAD HANDLING INSTRUCTIONS: H - TAKING-UP AND SETTING-DOWN A SUSPENDED LOAD).*

## PICKING UP THE ATTACHMENTS

### 1 - ATTACHMENT WITHOUT HYDRAULICS AND HAND LOCKING DEVICE

#### FITTING AN ATTACHMENT

- Ensure that the attachment is in a position facilitating the locking to the carriage. If it is not correctly oriented, take the necessary precautions in order to move it safely.
- Check that the locking pin is in position in the bracket (fig. A).
- Place the lift truck with the boom fully lowered in front of and parallel to the attachment, tilt the carriage forwards (fig. B).
- Bring the carriage under the locking tube of the attachment, slightly raise the boom, tilt the carriage backwards in order to position the attachment (fig. C).
- Lift the attachment off the ground to facilitate locking.

#### HAND LOCKING

- Take the locking pin on the bracket (fig. A) and lock the attachment (fig. D). Do not forget to fit the cotter pin.

#### HAND RELEASING

- Proceed in the reverse order to MANUAL LOCKING, making sure to refit the locking pin in the bracket (fig. A).

#### REMOVING THE ATTACHMENT

- Proceed in the reverse order to FITTING AN ATTACHMENT, taking care to store the attachment flat on the ground and in the closed position.

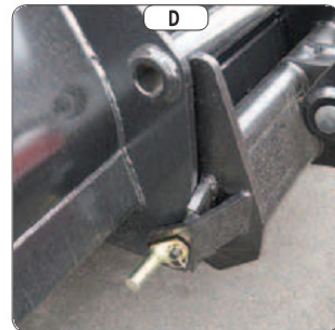
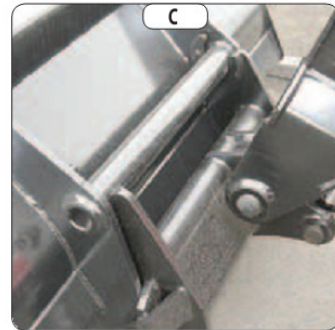
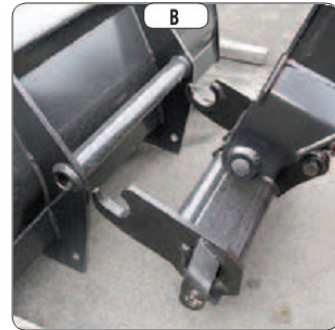
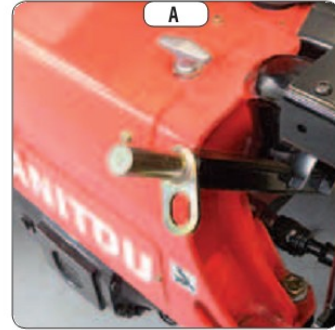

## 2 - HYDRAULIC ATTACHMENT AND MANUAL LOCKING DEVICE

### FITTING AN ATTACHMENT

- Ensure that the attachment is in a position facilitating the locking to the carriage. If it is not correctly oriented, take the necessary precautions in order to move it safely.
- Check that the locking pin is in position in the bracket (fig. A).
- Place the lift truck with the boom fully lowered in front of and parallel to the attachment, tilt the carriage forwards (fig. B).
- Bring the carriage under the locking tube of the attachment, slightly raise the boom, tilt the carriage backwards in order to position the attachment (fig. C).
- Lift the attachment off the ground to facilitate locking.

### MANUAL LOCKING AND CONNECTION OF THE ATTACHMENT

#### ⚠ IMPORTANT ⚠

*Make sure that the rapid connectors are clean and protect the holes which are not used, with the caps provided.*

- Take the locking pin on the bracket (fig. A) and lock the attachment (fig. D). Do not forget to fit the cotter pin.
- Stop the I.C. engine and keep the ignition on the lift truck.
- Release the pressure in the attachment hydraulic circuit by operating switch 1 on the distributor lever backwards and forwards 4 or 5 times.
- Connect the quick-release couplers according to the logic of the attachment's hydraulic movements.

### MANUAL RELEASE AND DISCONNECTION OF THE ATTACHMENT

- Proceed in the reverse order of paragraph MANUAL LOCKING AND CONNECTION OF THE ATTACHMENT, taking care to refit the locking pin in the bracket.

### REMOVING THE ATTACHMENT

- Proceed in the reverse order to FITTING AN ATTACHMENT, taking care to store the attachment flat on the ground and in the closed position.

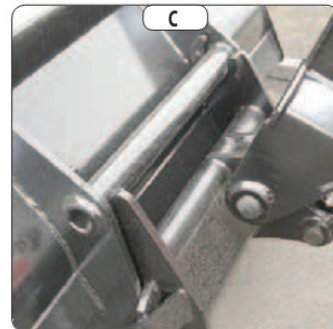
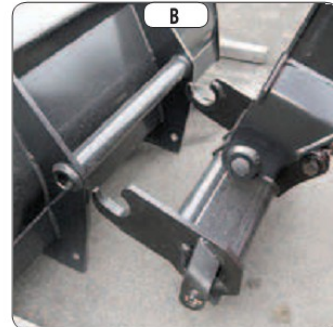
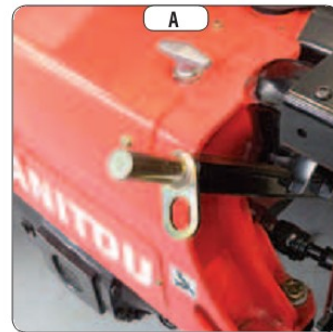

## TECHNICAL SPECIFICATIONS OF ATTACHMENTS

### STANDARDISED TILTING FORK CARRIAGE

	PFB 25 N MT-1020 S2	PFB 25 N MT-1260 S2
<b>PART NUMBER</b>	<b>571958</b>	<b>571959</b>
Rated capacity	2300 kg	2300 kg
Width	1020 mm	1260 mm
Weight	71 kg	80 kg

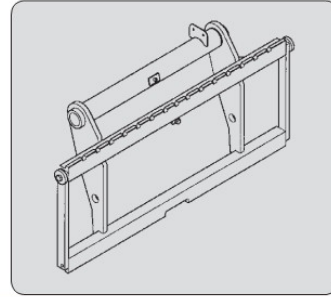

### STANDARDISED SIDE-SHIFT CARRIAGE

	TDL 2T5 L1020 FEM2	TDL 2T5 L1260 FEM2
<b>PART NUMBER</b>	<b>751370</b>	<b>751371</b>
Rated capacity	2300 kg	2300 kg
Déplacement latéral	2x100 mm	2x100 mm
Width	1020 mm	1260 mm
Weight	54 kg	67 kg

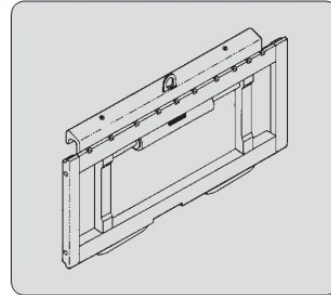

### STANDARDISED FORK

	415835
<b>PART NUMBER</b>	<b>415835</b>
Section	125x40x1200 mm
Weight	76 kg

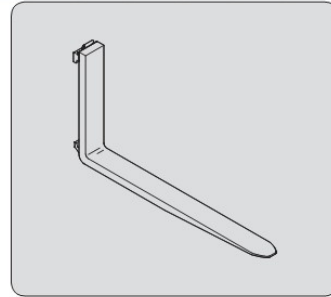

### LOAD BACK REST

	555320	570518
<b>PART NUMBER</b>	<b>555320</b>	<b>570518</b>
Width	1020 mm	1260 mm
Weight	31 kg	35 kg

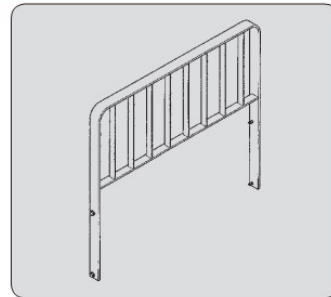

## FLOATING FORK CARRIAGE

<b>PART NUMBER</b>	<b>TFF29 MT-1040</b>
Rated capacity	653340 2900 kg
Width	1040 mm
Weight	285 kg

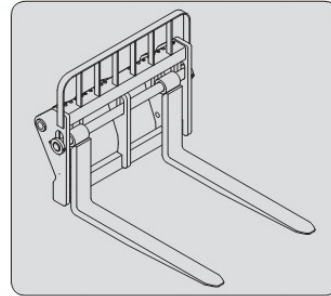

## FLOATING FORK

<b>PART NUMBER</b>	<b>211919</b>
Section	125x40x1200 mm
Weight	62 kg

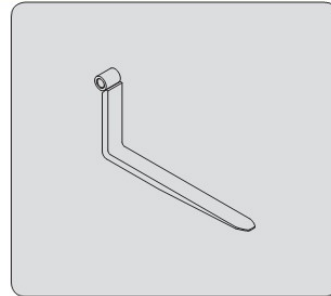

## BUILDING BUCKET

	<b>CBC 650 L1850</b>
<b>PART NUMBER</b>	<b>654473</b>
Rated capacity	676 l
Width	1850 mm
Weight	320 kg

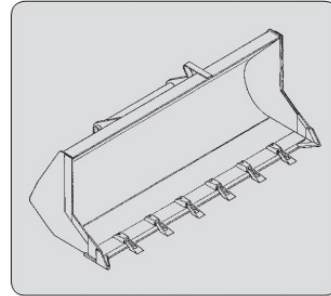

## LOADING BUCKET

	<b>CBR 730 L1850</b>
<b>PART NUMBER</b>	<b>571831</b>
Rated capacity	735 l
Width	1850 mm
Weight	330 kg

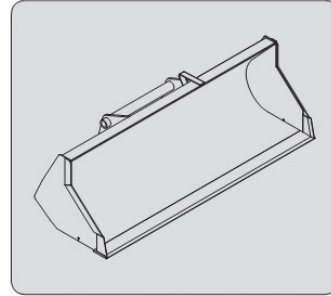

## MULTIPURPOSE BUCKET

	<b>CB4X1-700 L1950</b>
<b>PART NUMBER</b>	<b>751402</b>
Rated capacity	700 l
Width	1950 mm
Weight	640 kg

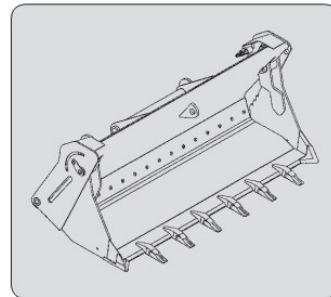



### CONCRETE BUCKET (ADAPTABLE ON FORKS)

<b>PART NUMBER</b>	<b>BB 500 S4</b>
	<b>654409</b>
Rated capacity	500 l/1300 kg
Width	1100 mm
Weight	205 kg

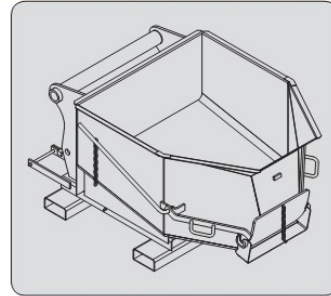

### CONCRETE BUCKET WITH SPOUT (ADAPTABLE ON FORKS)

<b>PART NUMBER</b>	<b>BBHG 500 S4</b>
	<b>751464</b>
Rated capacity	500 l/1300 kg
Width	1100 mm
Weight	235 kg

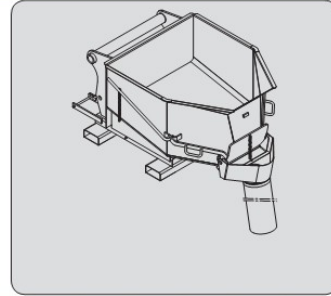

### SPOUT BUCKET (ADAPTABLE ON FORKS)

<b>PART NUMBER</b>	<b>GL 600 S2</b>
	<b>174373</b>
Rated capacity	600 l/1440 kg
Weight	290 kg

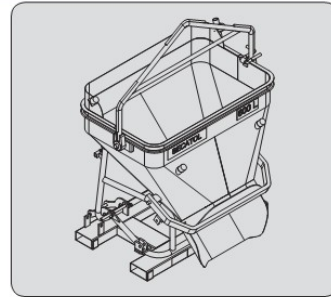

## CRANE JIB

<b>PART NUMBER</b>	<b>PC 50</b>
Rated capacity	708544
Weight	5000 kg
	120 kg

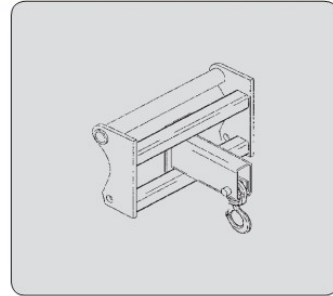

## ATTACHMENT SHIELDS

### FORK PROTECTOR

PART NUMBER 227801

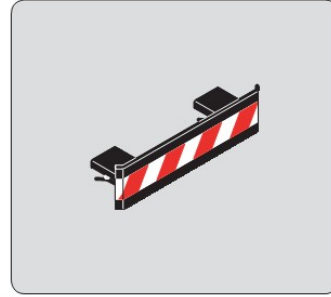

### FORK BLOCK FOR FLOATING FORK CARRIAGE

PART NUMBER 261210

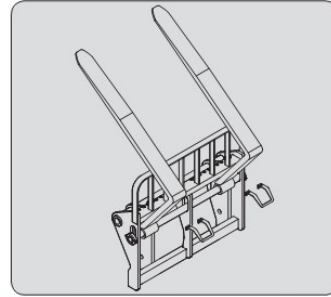

### BUCKET PROTECTOR

*Always ensure that the width of the protector you choose is less than or equal to the width of the bucket.*

PART NUMBER	206734	206732	206730
Width	1375 mm	1500 mm	1650 mm
PART NUMBER	235854	206728	206726
Width	1850 mm	1950 mm	2000 mm
PART NUMBER	223771	223773	206724
Width	2050 mm	2100 mm	2150 mm
PART NUMBER	206099	206722	223775
Width	2250 mm	2450 mm	2500 mm

